

eOne PLUS



www.etatronics.com

 **ETATRON D.S.**

IT NORME DI INSTALLAZIONE, USO E MANUTENZIONE

UK OPERATING INSTRUCTIONS AND MAINTENANCE

FR NOTICE D'INSTALLATION, EMPLOI ET ENTRETIEN





ETATRON D.S.

(IT) DIRETTIVA "RAEE" 2002/96/CE E SUCCESSIVA MODIFICA 2003/108/CE SUI RIFIUTI DI APPARECCHIATURE ELETTRICHE ED ELETTRONICHE

Il simbolo sotto riportato indica che il prodotto non può essere smaltito come normale rifiuto urbano. Le Apparecchiature Elettriche ed Elettroniche (AEE) possono contenere materiali nocivi per l'ambiente e la salute e pertanto devono essere oggetto di raccolta differenziata: smaltite quindi presso apposite discariche o riconsegnate al distributore a fronte dell'acquisto di una nuova, di tipo equivalente o facente le stesse funzioni. La normativa sopracitata, alla quale rimandiamo per ulteriori particolari e approfondimenti, prevede sanzioni per lo smaltimento abusivo di detti rifiuti.

(UK) WASTE OF ELECTRICAL AND ELECTRONIC EQUIPMENT DIRECTIVE (WEEE, RAEE in Italy) 2002/96/EC AND SUBSEQUENT AMENDMENT 2003/108/EC

The marking shown below indicates that the product cannot be disposed of as part of normal household waste. Electrical and Electronic Equipment (EEE) can contain materials harmful to health and the environment, and therefore is subject to separate waste collection: it must be disposed of at appropriate waste collection points or returned to the distributor against purchase of new equipment of similar type or having the same functions. The directive mentioned above, to which make reference for further details, provides for punitive actions in case of illegal disposal of such waste.

(FR) DIRECTIVE "RAEE" 2002/96/CE ET MODIFICATION SUCCESSIVE 2003/108/CE CONCERNANT LES REBUTS D'APPAREILLAGES ÉLECTRIQUES ET ÉLECTRONIQUES

Le symbole ci-dessous indique que le produit ne pas être éliminé comme un normal déchet urbain. Les Appareillages Électriques et Électroniques (AEE) peuvent contenir des matériaux nocifs pour l'environnement et la santé et doivent donc faire l'objet de collecte différenciée: éliminés donc auprès de décharges prévues à cet effet ou rendus au distributeur pour l'achat d'un nouveau, de type équivalent ou ayant les mêmes fonctions. La réglementation susmentionnée, à laquelle nous vous renvoyons pour les détails et les approfondissements ultérieurs, prévoit des sanctions pour la mise en décharge abusive desdits rebus.

(ES) DIRECTIVA "RAEE" 2002/96/CE Y MODIFICACIÓN SUCESIVA 2003/108/CE SOBRE RESIDUOS DE APARATOS ELÉCTRICOS Y ELECTRÓNICOS

El símbolo que se muestra abajo indica que el producto no puede eliminarse como un residuo urbano normal. Los Aparatos Eléctricos y Electrónicos (AEE) pueden contener materiales nocivos para el medio ambiente y la salud y por tanto tienen que ser objeto de recogida selectiva: por consiguiente tienen que eliminarse en vertederos apropiados o entregarse al distribuidor cuando se adquiera uno nuevo, del mismo tipo o con las mismas funciones. La normativa mencionada arriba, a la que remitimos para más detalles y profundizaciones, prevé sanciones por la eliminación clandestina de dichos residuos.



SAFETY STANDARDS.....	76
<i>Warnings.....</i>	76
<i>Symbols used in the manual</i>	76
<i>Dosage of hazardous and/or toxic liquids.....</i>	76
GENERAL INSTRUCTIONS	76
<i>Intended use of the pump.....</i>	76
<i>Transport and handling.....</i>	76
<i>Risks</i>	77
<i>Assembly</i>	77
<i>Disassembly.....</i>	77
<i>Warranty</i>	77
DOSING PUMPS EONE PLUS SERIES.....	78
<i>Operating principle.....</i>	78
<i>Technical Specifications</i>	78
<i>Reference Standards.....</i>	78
<i>Operating functions:.....</i>	78
<i>Additional functional principles</i>	79
<i>Overall dimensions.....</i>	80
<i>Materials in contact with the additive.....</i>	81
INSTALLATION.....	81
<i>Introduction</i>	81
<i>Pump installation</i>	81
<i>Electrical connection.....</i>	82
<i>Hydraulic Connection</i>	82
<i>Diagram of typical system.....</i>	83
<i>Supplied.....</i>	84
SPECIAL WARNINGS FOR THE METERING OF SULPHURIC ACID (MAX. 50%).....	84
OPERATIONAL INSTRUCTIONS (COMMISSIONING)	84
<i>Control Panel</i>	84
<i>PLUS Proportional and Metering pump</i>	85
<i>Injection Calibration Procedure.....</i>	85
DIAGRAM OF ELECTRICAL CONNECTIONS TO PERIPHERALS.....	86
OPERATIONAL FUNCTIONS OF THE PLUS "PROPORTIONAL" PUMP	87
<i>Manual</i>	87
<i>Proportional 1XN (VFT, MF, VFT-T, MF-T).....</i>	87
<i>Proportional 1XN (M) (VFT, MF, VFT-T, MF-T).....</i>	87
<i>Proportional 1:N (VFT, MF, VFT-T, MF-T).....</i>	87
<i>Proportional ml x imp (VFT-S, MF, VFT-S-T, MF-T).....</i>	87
<i>Proportional l x imp (VFT-S, MF, VFT-S-T, MF-T)</i>	87
<i>Proportional ml x m3 (VFT-S, MF, VFT-S-T, MF-T).....</i>	87
<i>Proportional ppm (VFT-S, MF, VFT-S-T, MF-T).....</i>	88

<i>Proportional mA (VFT-S, MF, VFT-S-T, MF-T)</i>	88
---	----

OPERATING FUNCTIONS DIAGRAMS OF THE PLUS "PROPORTIONAL" PUMP..... 89

<i>Flow Diagram main menu</i>	89
<i>Flow Diagram Manual mode</i>	90
<i>Flow Diagram 1xN mode</i>	90
<i>Flow Diagram 1xN(M) mode</i>	90
<i>Flow Diagram 1 ÷ N mode</i>	91
<i>Flow Diagram ml x P mode</i>	91
<i>Flow Diagram l x P mode</i>	91
<i>Flow Diagram ml x m³ mode</i>	92
<i>Flow Diagram PPM mode</i>	92
<i>Flow Diagram mA mode</i>	93

OPERATIONAL FUNCTIONS OF THE PLUS "METERING" PUMP 94

<i>Manual</i>	94
<i>pH mode</i>	94
<i>RX mode</i>	95
<i>Cl mode</i>	95
<i>ppm mode</i>	95

OPERATING FUNCTIONS DIAGRAMS OF THE PLUS "METERING" PUMP..... 96

<i>Flow Diagram main menu</i>	96
<i>Flow diagram PH mode</i>	97
<i>Flow diagrams pH mode submenu</i>	97
<i>Flow diagram RX mode</i>	100
<i>Flow diagrams RX mode submenu</i>	100
<i>Flow diagram CL mode</i>	103
<i>Flow diagrams CL mode submenu</i>	103
<i>Flow diagram ppm mode</i>	106
<i>Flow diagrams ppm mode submenu</i>	106

FUNCTIONS ACCESSORIES OF THE PLUS PUMP..... 109

<i>Remote Control - Level - Proximity (Instrument versions only)</i>	109
<i>Flow rate per impulse (proportional versions only)</i>	109
<i>Setting the maximum frequency</i>	109
<i>PPM Scale setting</i>	109
<i>Alarms</i>	109
<i>Clock</i>	109
<i>Password</i>	109
<i>Temperature (Instrument versions only)</i>	110
<i>Activation delay (Instrument versions only)</i>	110
<i>Mode menu (Instrument versions only)</i>	110
<i>Language</i>	110
<i>Reset</i>	110

FLOW DIAGRAM SETTINGS MENU 111

<i>Flow diagram submenu REMOTE CONTROL/LEVEL/PROXIMITY</i>	112
--	-----

<i>Flow diagram submenu FLOW RATE PER IMPULSE (only proportional versions)</i>	112
<i>Flow diagram submenu PPM SCALE VALUES (only metering versions)</i>	113
<i>Flow diagram submenu MAXIMUM FREQUENCY</i>	113
<i>Flow diagram alarm settings submenu</i>	113
<i>Flow diagram CLOCK submenu</i>	114
<i>Flow diagram PASSWORD submenu</i>	115
<i>Flow diagram TEMPERATURE submenu (only metering versions)</i>	115
<i>Flow diagram MODES MENU submenu (only metering versions)</i>	116
<i>Flow diagram START DELAY submenu (only metering versions)</i>	116
<i>Flow diagram LANGUAGE submenu</i>	116
<i>Flow diagram RESET submenu</i>	117
ALARMS	118
<i>Level alarm</i>	118
<i>Flow switch alarm</i>	118
<i>Meter impulses alarm (only proportional versions)</i>	118
<i>Maximum value and minimum value alarms (Instrument versions only)</i>	119
<i>Overdose alarm (only Instrument versions)</i>	119
<i>UNDER-LOAD and OVER-LOAD alarms</i>	119
<i>Relay services output</i>	120
FLOW DIAGRAM ALARM SETTINGS MENU	121
<i>Flow diagram LEVEL ALARM</i>	122
<i>Flow diagram FLOW METER ALARM</i>	122
<i>Flow diagram WATER METER PULSE ALARM (proportional versions only)</i>	123
<i>Flow diagram PPM WATER METER PULSE ALARM (proportional versions only)</i>	123
<i>Flow diagram ml x m³ WATER METER PULSE ALARM (proportional versions only)</i>	124
<i>Flow diagram MAXIMUM MEASURE ALARM (metering versions only)</i>	124
<i>Flow diagram MINIMUM MEASUREMENT ALARMS (metering versions only)</i>	125
<i>Flow diagram OVERDOSE ALARM (metering versions only)</i>	125
<i>Flow diagram OVERLOAD ALARM</i>	126
<i>Flow diagram UNDERLOAD ALARM</i>	126
PROGRAMMABLE TIMER FUNCTION DAILY AND WEEKLY	127
<i>Flow diagram TIMER function</i>	127
ROUTINE MAINTENANCE	130
UNSCHEDULED WORK IN THE EVENT OF A BREAKDOWN	130
<i>MECHANICAL FAULTS</i>	130
<i>ELECTRICAL FAULTS</i>	130
ANNEX 1 - PUMP DRAWINGS	131
ANNEX 2 – ENLARGED VIEWS (PUMP AND INJECTION VALVE)	132
ANNEX 2 - ENLARGED VIEWS	133

SAFETY STANDARDS

Warnings

Carefully read the warnings listed below as they provide important information regarding safe installation, use and maintenance. Store this manual carefully for future reference.

PLEASE NOTE: The pump is made to perfection. Its durability, electrical and mechanical reliability will be enhanced if it is correctly used and undergoes regular maintenance.

WARNING: Any intervention or repair within the equipment must be carried out by qualified and authorized personnel. We disclaim all responsibility as a result of non-observance of this rule.

Symbols used in the manual

		
<p>PROHIBITED Precedes information that is inherent to safety. It flags something that is not to be done.</p>	<p>WARNING Precedes a text that is very important for the protection of the health of exposed persons or for the machine itself.</p>	<p>INFORMATION NOTICE Precedes information concerning the use of the equipment.</p>

Dosage of hazardous and/or toxic liquids.

To avoid damage to persons or property arising from contact with hazardous liquids or toxic fumes, in addition to compliance with the instructions contained in this booklet, the following standards should be made well aware of:

- Operate as recommended by the manufacturer of the liquid (additive) to be used.
- Check that the hydraulic part of the pump is not damaged or broken and use the pump only when in perfect condition.
- Use tubes suitable for the liquid and the operating conditions of the plant, inserting them possibly inside PVC protection tubes.
- Before you turn off the dosing pump you must neutralize the hydraulic part with the proper reagent.



GENERAL INSTRUCTIONS

Intended use of the pump

The pump should be used only for the purpose for which it was expressly designed, namely the dosing of liquids. Any other use is considered improper and therefore dangerous. The pump is not intended to be used for applications not foreseen in the design phase. For further information the customer is required to contact our office where you will receive information on the type of pump in his possession, and its proper use. The manufacturer cannot be held responsible for any damage caused by improper, incorrect or unreasonable use.

The electronic dosing pump must be used to dose small amounts of additive to modify the concentrations of treated liquid.

Transport and handling

Transport must be carried out with respect to the orientation shown on the packaging. The expedition carried out by whatever means, even if carriage paid by the buyer or recipient, is to be carried out at the purchaser's risk. A claim for missing materials must be received within 10 days of receipt of the goods, and within 30 days for defective goods. If pumps have to be returned it must be agreed beforehand with authorised personnel or with the official distributor.





Risks

Once the packaging has been removed, check the pump, and if in doubt do not use the pump and consult with qualified personnel. The packaging materials (such as plastic bags, polystyrene, etc..) must not be left within reach of children as they are potential sources of danger.

Before connecting the pump, make sure that the data on the plate corresponds to that of the power distribution network. The nameplate data is shown on the adhesive label attached to the pump.

The electrical installation must comply with the rules in force in the country where the plant is installed.

The use of any electrical equipment involves the observance of some fundamental rules. In particular:

- do not touch the equipment with wet or damp hands or feet;
- do not operate the pump with bare feet (e.g. swimming pool equipment);
- do not leave the equipment exposed to atmospheric agents (rain, sun, etc.)
- do not allow the pump to be used by children or by an incapacitated person without supervision.

In case of failure and / or malfunction of the pump, turn it off and do not tamper with it. For any repairs please contact our service centres and request the use of original spare parts. Failure to comply with the above may compromise the safety of the pump.

If you decide to no longer use an installed pump it is recommended to make it inoperative by disconnecting it from the power supply and emptying the pump body.

If there are leaks from the hydraulic part of the pump (breakage of seals, valves, pipes), you must stop the operation of the pump, depressurise the discharge pipe and proceed with maintenance using appropriate safety measures (gloves, goggles, overalls, etc.).

Assembly

All Etatron DS dosing pumps are usually supplied already assembled. For greater clarity, you can consult the attachment at the bottom of the manual which illustrates an enlarged view of the pump, and all the details with its nomenclature, so that you can have a complete picture of the pump components. These drawings are however indispensable if you have to identify malfunctioning or defective parts. Other designs, related to the hydraulic parts (pump head and valves) are shown for the same purpose, in the appendix.

Disassembly

For the eventual dismantling of the pump or before starting work on it:

- Make sure that it is turned off electrically (both polarities) by disconnecting the connection cables from the contact points of the network through the opening of a phase switch with a minimum contact gap of 3 mm (Fig. 6).
- In an appropriate manner, carefully dispose of any remaining pressure from the pump body and from the injection tube.
- Remove all liquid present from the pump body, then proceed by disassembling and reassembling the pump body, by unscrewing and screwing the four screws (tightening torque: 180 to 200 N * cm).

This last point requires special attention, so please refer to the drawings in Annex 1 and the chapter "**RISKS**" before starting any operation.

Warranty

2 years (excluding parts subject to normal wear i.e.: valves, fittings, tube fixing clamps, tubes, seals, filter and injection valve). Improper use of the equipment invalidates the warranty. The warranty is intended to be Ex Works or authorized distributors.





Operating principle

The operation of the dosing pump is provided by a membrane in PTFE (Teflon ®) mounted on the piston of an electromagnet. When the piston of the electromagnet is attracted, a pressure is produced in the pump body with an ejection of liquid from the discharge valve. Once the electric impulse is over a spring returns the piston to its initial position with a recall of liquid through the suction valve. Given the simplicity of operation the pump does not need lubrication and requires very little maintenance. The materials used for the construction of the pump make it suitable for the dosage of chemically aggressive liquids. The dosing pump is designed for capacities ranging from 1 to 30 l / h and pressures of 4 to 20 bar depending on the model.

Technical Specifications

- Equipment manufactured in accordance with EC standards.
- External casing made out of plastic material resistant to acid and temperature.
- Control panel protected with serigraphic film.
- Multi voltage power supply 100-250 V 50-60 Hz
- Degree of protection: IP65
- Environmental conditions: indoors, maximum altitude 2000 m, room temperature from 5 ° C to 40 ° C, maximum relative humidity 80% up to a maximum of 31 ° C (decreasing linearly until it is reduced to 50% at 40 ° C)
- Classification with respect to protection against direct contacts: CLASS I, the equipment is supplied with a protective conductor

Reference Standards

The dosing pump complies with the following directives:

- 2006/95/EC: "Low tension"
- 2004/108/EC: "Electromagnetic compatibility"

Operating functions:

When first turned on the user can choose between different operation modes as best illustrated in the following chapters. In general, the pump can operate in the modes specified in the following table.

Modes	Description
MANUAL	The pump doses in a continuous manner up to a maximum of 300 injections per minute (the number of injections / minute changes as a function of the maximum capacity). The flow rate is adjustable by the user in the programming phase.
PROPORTIONAL Meter	In this mode the pump receives impulses from an external meter, the pulses are managed in one of the following operational functions: <ul style="list-style-type: none"> • 1 x N: each impulse of the meter corresponds to the N injections of the pump. • 1 x N(M): each meter impulse corresponds N of the pump, with storage for up to 4 * N impulses from the meter during dosing. • 1 / N: each N impulses of the meter corresponds to a single pump impulse. • ml x imp: at each meter impulse the pump dispenses a pre-determined amount of additive in millilitres. • l x imp: at each meter impulse the pump dispenses a pre-determined amount of additive in litres.
PROPORTIONAL ppm - ml x m³ from the meter	The pump doses directly in ppm (Parts Per Million) or else in ml x m³ (millilitres per cubic metre). The device automatically carries out all calculations necessary to provide the required concentration.
PROPORTIONAL from mA input	The pump doses in proportion to a 4-20 mA current signal coming from an external transducer. The setting of maximum and minimum values can be set in the respective set-up menu.
INSTRUMENT PH, Rx, Cl, PPM	Electrodes for the measurement of pH, REDOX potential and probes for specific chemical species (Cl ppm), can be connected to the pump.

Additional functional principles

Function	Description
FLOW SWITCH ALARM	The pump controls by means of the flow-status (available on request and inserted on the pump delivery), the actual injections delivered, signalling any anomaly, by means of the LED alarm and the switching the relevant relay (if enabled).
LEVEL ALARM	Operational if enabled in all functional modes, the opening or closing of the contact on the level probe, indicates the end of the additive in the tank, the pump stops and the relay switches (if enabled).
UNDERLOAD ALARM	Operational if enabled in all functional modes, the system controls the intake and in the absence of liquid in the tank, of an inoperative valve, of the air inlet of the suction tube being disconnected etc., the pump will stop and the relay switches (if enabled).
OVERLOAD ALARM	Operational if enabled in all functional modes, the system checks the flow and in the event of overpressure in the pump body, caused by an obstruction in the discharge line or by a high operating pressure which exceeds the pump features, the pump will stop and the relay switches (if enabled).
TOO MANY IMPULSES ALARM	The pump, in 1xN (M) and PPM ml x m ³ mode, controls at all times the number of injections that have yet to be carried out. If they are greater than an amount equal to 4 × N, where N is the impulses to be delivered for each contact, the pump will go into alarm resulting in LED lights and the intervention of the relevant relay.
MINIMUM AND MAXIMUM ALARM	In the instrument version you can set minimum and maximum thresholds on the measured quantity exceeded which causes the pump to signal an alarm.
OVERDOSE ALARM	In the instrument version you can set a continuous operation time threshold after which the pump signals an alarm.
RELAY SERVICES OUTPUT	Activated by the menu of all the above alarms, allows for remote signalling of alarms. Features: 1 changeover - 250V a.c. 5 Amp (resistive load).
CURRENT OUTPUT (mA)	The pump in the control configuration (pH, RX, Cl, ppm), has a current output (4-20 mA), directly proportional to the reading of the measurement carried out by the instrument
TEMPERATURE PROBE	A PT100 two-wire temperature probe can be connected to the pump.
CLOCK	Possibility to set the date and time, parameters necessary if the mode with timer (TIMER) is activated.
PROXIMITY OR LEVEL REMOTE CONTROL	Remote monitoring of the state of activation of the pump (Start / Stop). Possibility of choosing between a contact normally open or closed. (NORMAL or REVERSE polarity). In the case of control configuration, it is possible to activate the input for connection to the proximity sensor which detects the passage of the flow in the probe holder and enables the operation of the pump.
FREQUENCY MAXIMUM	Possibility of reducing and setting the maximum frequency of the pump in accordance with the needs of the system.
TIMER	Weekly and daily timer. 16 cycles ON / OFF daily. Settable per minute
LANGUAGE	Language Selection menu. Italian / English
TYPE OF MENU	In the control configuration it is possible to determine the level of complexity of the programming menu: simplified and complete.
RESET	Ability to perform two types of reset: "soft" to reset the settings of all the functions, "hard" to reconfigure the mode of use of the device (proportional or instrument) and to restore the factory settings.

The pump is equipped with a power supply board that regulates the power absorbed as a function of the operating pressure. (excluding the BASIC series). The following table shows the technical features of the eOne series and the corresponding flow curves:

Type	Flow at Max Pressure			Pressure max [bar]	Setting [imp/1']	Electric Power supply	Power [W]	Current MAX [A]	Weight [kg]
	L/h	mL/min	mL/stroke						
0110	1	16.66	0.09	10	0 - 180	100 -250 V 50-60 Hz	19	1.4	3.0
0310	3	50.00	0.21	10	0 - 240		21	1.4	3.0
0507	5	83.33	0.27	7	0 - 300		21	1.4	3.5
0520	5	83.33	0.46	20	0 - 180		28	2.0	4.5
0810	8	133.33	0.45	10	0 - 300		26	1.8	3.5
1010	10	166.66	0.55	10	0 - 300		36	1.8	4.5
1504	15	250.00	0.83	4	0 - 300		26	1.8	3.5
2005	20	333.33	1.38	5	0 - 240		32	1.9	4.5
3005	30	500.00	2.08	5	0 - 240		32	1.9	4.5
0210(*)	2	33.33	0.18	10	0 - 180		36	1.6	3.0
0507(*)	5	83.33	0.46	7	0 - 180		36	1.6	3.0

(*) BASIC model only

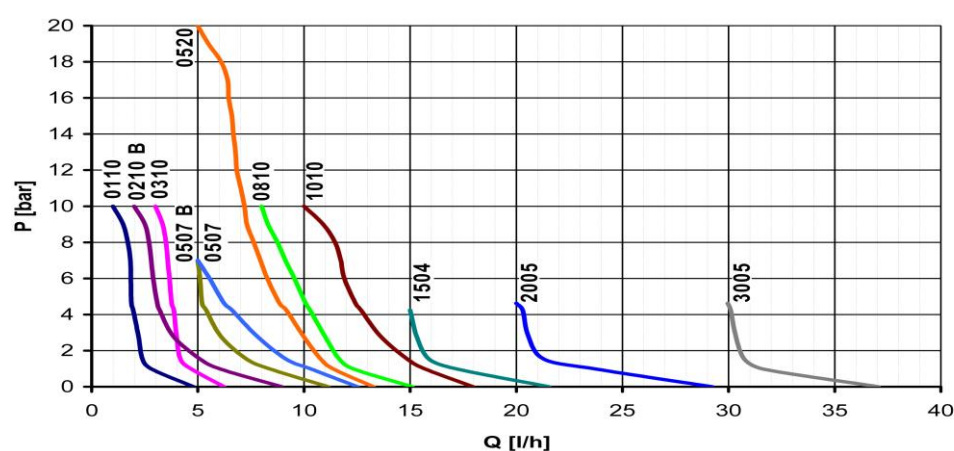

The values shown are with a tolerance of + / - 5%, and relate to a series of tests carried out on similar equipment with water at a temperature of 20 ° C.

Overall dimensions

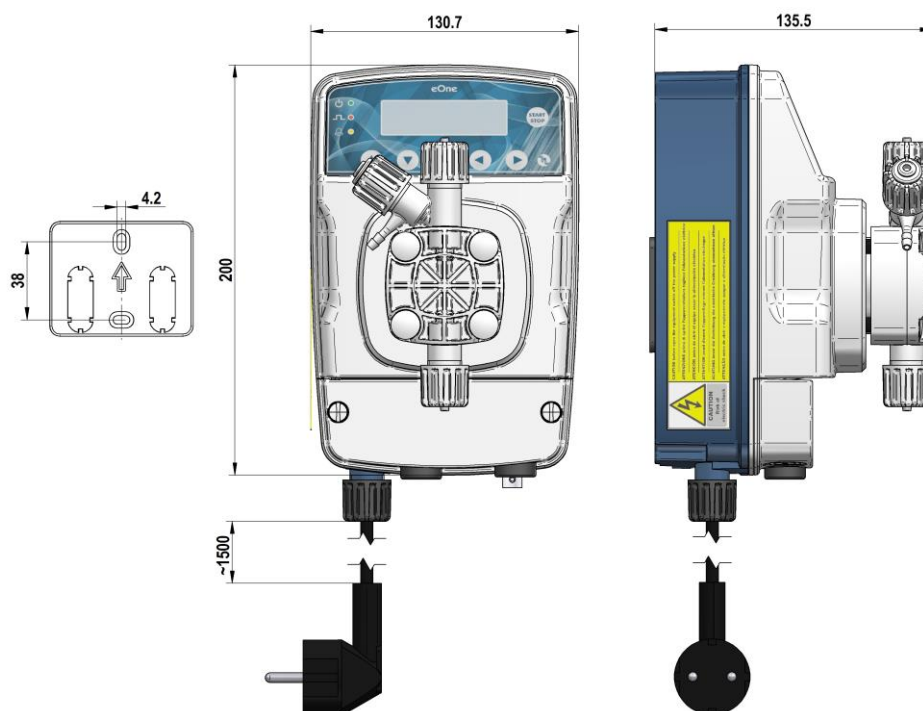

Fig. 1 - Pump and plate for wall mounting (dimensions in mm.).



Materials in contact with the additive

In the standard configuration the pumps of the "eOne" series are supplied with the following materials:

Pump casing	Membrane	Seals	Valves	Connections	Pipes
PVC	PTFE	TFE/P	CERAMIC TFE/P	PVDF	PE / PVC

INSTALLATION



Introduction

This section describes the steps for installing the pump, the pipes, and the electrical wiring. Read these instructions carefully before beginning any activity.

Follow these guidelines when installing the pump.

- Ensure that the pump and all related equipment is turned off before starting work.
- If you encounter abnormalities or warning signals, stop immediately. Only start work again when you are absolutely sure that you have removed the cause of the problem.
- Do not install the pump in hazardous locations or in areas at risk of fire or explosion.
- Avoid electrical hazards and fluid leakage. Never use a damaged or defective pump.

Pump installation

Install the pump away from heat sources and in a dry place at a maximum ambient temperature of 40 ° C. The minimum temperature, not lower however than 0 ° C, depends on the type of liquid to be metered, which must always remain in a liquid state. To fasten the pump use the supplied screw anchors, or those most suited to the support type chosen.

The pump can be installed either above or below the liquid level in the tank. Usually in the case of installation above the tank, limit the suction height to within 1.5 metres of the liquid level. (see fig. 2a). For liquids that generate aggressive vapours, do not install the pump into direct contact with the fumes and adopt the necessary precautions to prevent early deterioration of the equipment.

In the case of installation below, i.e. with the pump positioned below the liquid level of the tank (Fig. 2b), siphoning may occur. **Periodically check the functionality of the injection valve, as excessive wear may lead to the additive falling into the plant even with the pump turned off.** If the problem persists, fit a back pressure valve C suitably calibrated between the metering pump and the injection point as shown in Fig. 2b



Fig. 2a

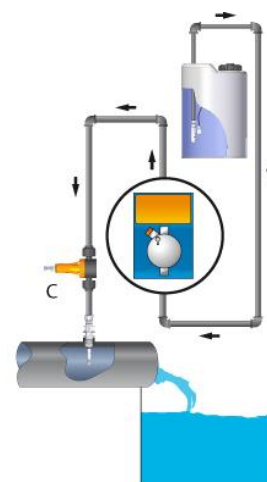

Fig. 2b

Electrical connection



Comply with the rules in force in the various countries with respect to the electrical installation. If the power cable is devoid of a plug, the equipment must be connected to the mains supply via a double pole isolator switch with a minimum distance between contacts of 3 mm. **Before accessing any of the connection devices, all supply circuits must be interrupted (Fig. 6).**

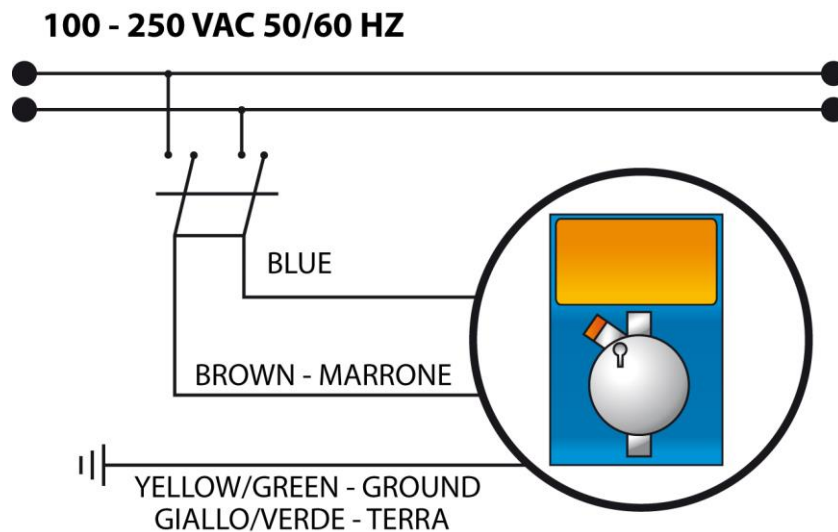

Fig.3 – Electrical Connection

Hydraulic Connection



The flow connection will always remain in the upper part of the pump from where the tube goes to the system to be treated. The suction fitting therefore will always be in the lower part of the pump, where the tube with the filter will be mounted that goes to the container of the liquid to be metered.

1. Remove the seal on the nut (2)
2. Insert the pipe through nut (2) and the bushing (3)
3. Push the end of the tube (1) on the conical spout of the nozzle (4)
4. Pull the nozzle (4) on the connector (5)
5. Tighten the nut (2) on the connector (5)

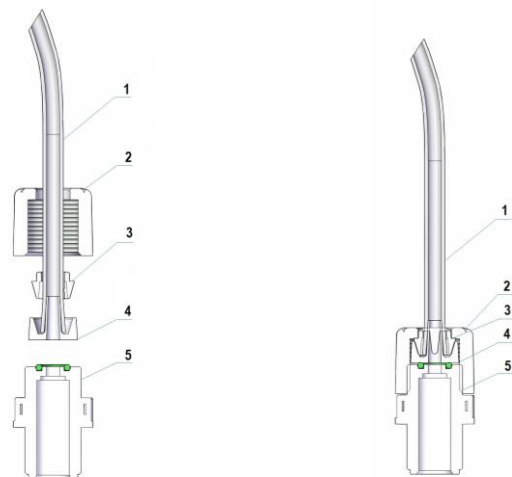

Fig.4 – Hydraulic Connection

To prime the pump, connect the discharge tubing and follow the sequence shown in Figure 5.

- unscrew the bleeding knob, with the pump running,
- keep the bleed valve B open until all the air contained in the tube and in the pump body comes out,
- close the bleed valve.

If you are experiencing difficulty in priming the pump, then with a syringe withdraw the additive from the bleed nipple reducing the number of impulses delivered by the device.

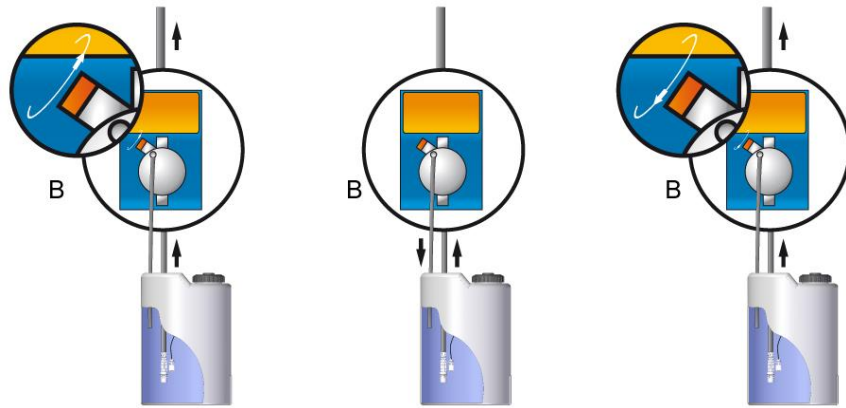

Fig.5 – Bleed operation for priming

Diagram of typical system

- A Injection fitting
- B Injection valve
- C Back pressure valve
- D Pressure Gauge
- E Relief valve
- F Electrical power socket
- G Additive tank
- H Bottom filter
- I Level probe

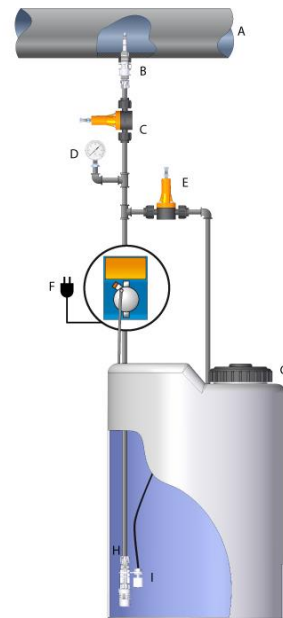

Fig. 6 – Typical Plant

Both on the flow pipe and the suction pipe avoid excessive curves in order to prevent bottlenecks in the pipe itself. In the point most suitable for the injection of the product to be dispensed, apply a 3/8" fitting or a 1/2" female gas thread on the conduct of the plant to be treated. This fitting is not supplied. Screw the injection valve to the "gasket fitting" using PTFE tape, see Fig 7. Connect the tube to the conical injection valve and secure it with the locking ring (4). The injection valve is also a non-return valve.



1. plant to be treated
2. 3/8" - 1/2" conical connection
3. injection valve
4. locking ring for pipe connection
5. pump flow tube
6. PTFE tape

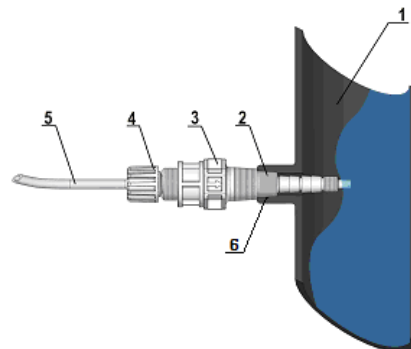

Fig. 7 - Connection assembly

Supplied



The following is supplied with the pump:

- 4 m of PVC flexible transparent suction tube
- 2 m semi-rigid polyethylene opaque delivery hose
- n. 1 3/8" - 1/2" BSP injection valve
- n. 1 bottom filter
- n. 1 set of instructions

SPECIAL WARNINGS FOR THE METERING OF SULPHURIC ACID (MAX. 50%)

In this case it is essential to bear in mind the following:



- replace the transparent PVC suction hose with a semi-rigid polyethylene delivery tube.
- remove in advance all the water present in the pump body, in fact if this is mixed with the sulphuric acid it generates a strong concentration of gas resulting in the overheating of the area causing damage to the valves and the pump body.

If the equipment is not attached to the system you can carry out this operation, by activating the pump for a few seconds (15-30) holding it upside down with no tubes connected to the fittings, if that is not possible then disassemble and reassemble the pump body (Fig .10), via the four fixing screws.

OPERATIONAL INSTRUCTIONS (COMMISSIONING)

Control Panel

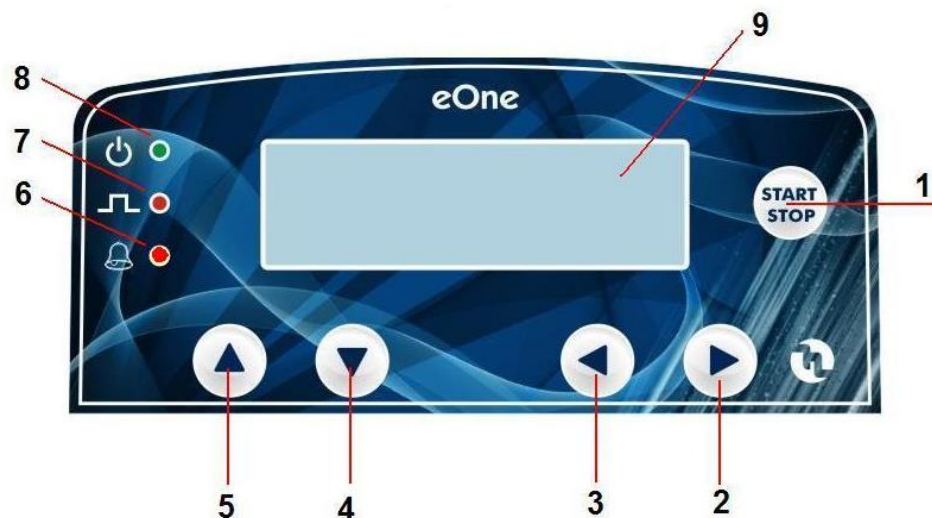

Fig. 8 – Control and Display Panel

1	Start and Stop Button
2	Right Values Button
3	Left Values Button
4	Values Reduction Button
5	Values Increase Button
6	Red LED flow status alarm / power failure alarm / maximum acceptable impulse difference alarm
7	Injections signalling red LED
8	Bi-colour LED pump powered / Stand by
9	Graphic Display



PLUS Proportional and Metering pump

The metering pump can operate in either Proportional or control mode pH, Rx or PPM meter. At the first power on you can choose the operating configuration of the equipment.

With reference to the following table, the operator can select the mode that best suits his metering needs: only some of the many programming menus will be made available, so you get a simplification and speeding up of the device commissioning.

Configuration	Type	Operating functions:													
		MANUAL	1 x N	1 x N (m)	1 / N	mL / imp.	L / imp.	mL / m ³	PPM	mA	Timer	PH Instrument	RX Instrument	CL (PPM) Instrument	
VFT	FW01	✓	✓	✓	✓										
VFT-S	FW02	✓				✓	✓	✓	✓	✓					
MF	FW03	✓	✓	✓	✓	✓	✓	✓	✓	✓					
ST	FW04	✓										✓	✓	✓	
VFT-T	FW05	✓	✓	✓	✓						✓				
VFT-S-T	FW06	✓				✓	✓	✓	✓	✓	✓				
MF-T	FW07	✓	✓	✓	✓	✓	✓	✓	✓	✓	✓				
ST-T	FW08	✓									✓	✓	✓	✓	

Once the configuration is set, scrolling the menu with the RIGHT (◀) and LEFT (▶) arrow keys, confirm the choice with the START / STOP button. **For an eventual reconfiguration it is necessary to do a TOTAL RESET.**



Injection Calibration Procedure

For accurate metering, in the eOne and MF Plus models we have implemented the option to automatically or manually set the actual flow rate for each injection. The following describes the practices that must be observed for "AUTOMATIC" calibration:

- Fill a graduated cylinder with the additive to be dosed by the pump and immerse the suction tube in it.
- Connect the delivery pipe of the metering pump to the plant to be treated.
- From the "SETTINGS" menu select the function "FLOW CAPACITY" and select the "AUTOMATIC" mode.
- Press the DOWN ARROW button to proceed to the priming of the metering pump which will begin to emit injections, until the pump body and the two suction and discharge pipes are full.
- Once finished priming press the DOWN ARROW button.
- Select the frequency of calibration procedure by press RIGHT AND LEFT ARROW buttons (standard value is 150 imp/min.).
- Press DOWN ARROW button. The pump will run for one minute.
- Once the injections are finished the metering pump will have suctioned a certain amount of additive whose quantity can be calculated by means of the scale on the cylinder.
- The amount of suctioned fluid, for example: 110 ml, should be set on the display and via the ARROW DOWN button the selected value will be confirmed.
- The logic of the pump will run the following operation:
value of additive suctioned / number of impulses delivered = flow rate of each injection
(110 / 150 = 0.73)
- the factory-set value of **0.45 ml** will become **0.73 ml**.

DIAGRAM OF ELECTRICAL CONNECTIONS TO PERIPHERALS



To connect the accessories and peripherals to the pump remove the front cover "1", using a flat-tip screwdriver on the two plastic screws, to access the terminal board (see Figure 9).

The "3" terminal board features spring terminals (there are no screws) for quick connection of the cables: press with a small screwdriver at the "carved" square pin and insert the conductor previously stripped in the corresponding terminal.

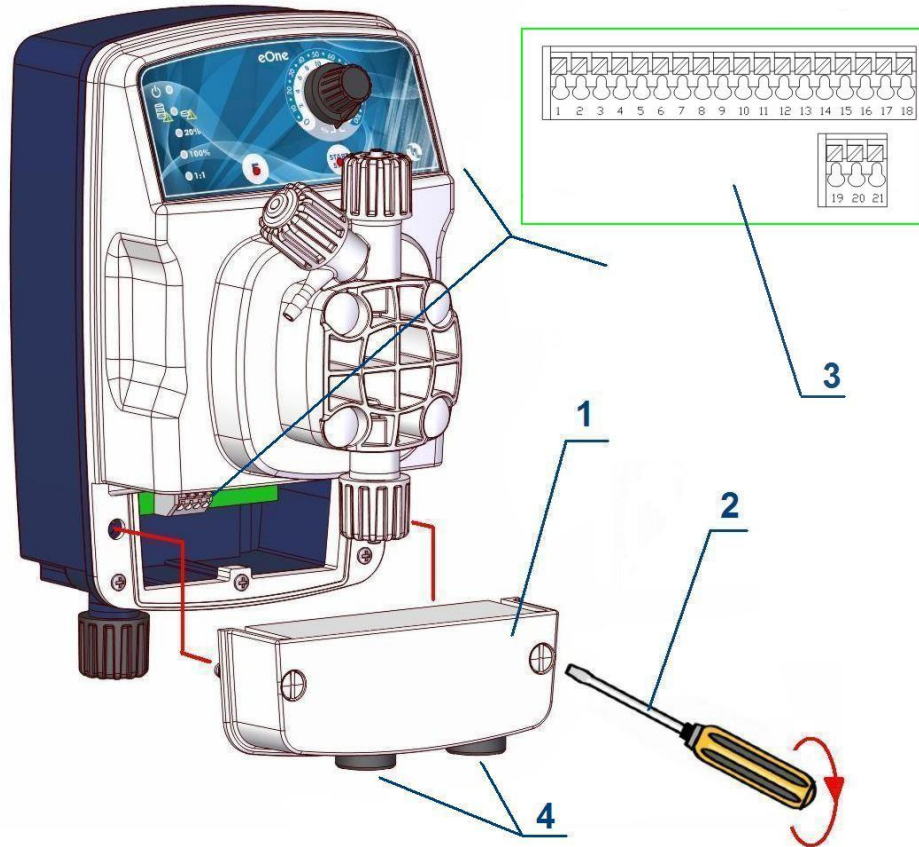

Fig. 9 – Terminal Board

N° Terminal	Description	N° Terminal	Description
1	mA (-) Input	12	Not Connected
2	mA (+) Input	13	Not Connected
3	Meter Input (-)	14	PT100 (-) Input
4	Meter Input (+)	15	PT100 Input (+)
5	Level Input (-)	16	Not Connected
6	Level Input (+)	17	Probe (Cl) PPM (-VCL)
7	Flow Switch Input (-)	18	Probe (Cl) PPM (+VCL)
8	Flow Switch Input (+)	19	Alarm Relay (NO)
9	Output mA (-)	20	Alarm Relay (NC)
10	Output mA (+)	21	Alarm Relay (COM)
11	Not Connected		



The connector for the pH, RX, or Cl probe is placed in the lower part of the metering pump.

OPERATIONAL FUNCTIONS OF THE PLUS "PROPORTIONAL" PUMP



In order to facilitate the consultation of this manual, the configuration with the function described is shown in the subsection titles.

Manual

This configuration is present in all versions. The metering pump operates at a frequency predetermined by the user within the following range:

- **0 to 300 impulses / minute** (depending on the maximum flow)
- **0 to 60 impulses / hour**
- **0 to 24 impulses / day**

During the operational phase of the manual mode, you can view the impulses / minute, the rate of dosage or the actual litres / hour delivered by the pump; use the left or right arrow keys to select the desired display.

Proportional 1XN (VFT, MF, VFT-T, MF-T)

The pump is provided with a connector for connection to an external water meter which can provide a series of contacts proportional to the amount of liquid that must be treated. A flashing dot on the display shows the input impulse from the meter.

For each contact received, the pump delivers a series of injections equal to the N value set by the operator. Any contacts that come from the meter to the pump, while it is already delivering the N series of injections, are ignored.

Proportional 1XN (M) (VFT, MF, VFT-T, MF-T)

Unlike the previous mode, in this one the pump stores any received impulses in the memory while it is delivering injections.

Depending on the time interval between impulses coming from the meter, the pump automatically adjusts the frequency of the injections. If the injections accumulated and still to be dispensed, exceed the value "4 × N", the pump will go into alarm (if this alarm has been enabled) and stop the metering. The display shows dynamically the number of injections that must be provided.

Proportional 1:N (VFT, MF, VFT-T, MF-T)

The pump is provided with a connector for connection to an external water meter which can provide a series of contacts proportional to the amount of liquid that must be treated. Every N contacts received by the meter, the pump delivers an injection. The display shows the number of contacts received up to the set value. At the delivery of the impulse the display resets and begins the next count.

Proportional ml x imp (VFT-S, MF, VFT-S-T, MF-T)

The pump is provided with a connector for connection to an external water meter which can provide a series of contacts proportional to the amount of liquid that must be treated. For each contact, received from the meter, the pump delivers a number of injections directly proportional to the set value in "ml" (millilitres) requested by the user. The display shows in a dynamic manner the amount dosed in "ml".

Proportional l x imp (VFT-S, MF, VFT-S-T, MF-T)

As for the previous mode with the difference being that displayed in litres.

Proportional ml x m3 (VFT-S, MF, VFT-S-T, MF-T)

For those who need a ml x m3 metering a specific function has been provided: by setting the required parameters in the programming menu, the electronic system performs the necessary calculations and determines the type of intervention required to effect the pump. The parameters that must be defined are the following:

L / I METER Sets the litres per impulse that are delivered by the meter used in the system, the expected types are as follows:
0.1 – 0.15 – 0.20 – 0.25 – 0.30 – 0.35 – 0.40 – 0.45 – 0.50 – 0.55 – 0.60 – 0.65 – 0.70 – 0.75
– 0.80 – 0.85 – 0.90 – 0.95 – 1 – 1.5 – 2 – 2.5 – 3 – 3.5 – 4 – 4.5 – 5 – 5.5 – 6 – 6.5 – 7 – 7.5
– 8 – 8.5 – 9 – 9.5 – 10 – 15 – 20 – 25 – 30 – 35 – 40 – 45 – 50 – 55 – 60 – 65 – 70 – 75 – 80
– 85 – 90 – 95 – 100 – 150 – 200 – 250 – 300 – 350 – 400 – 450 – 500 – 550 – 600 – 650 –
700 – 750 – 800 – 850 – 900 – 950 – 1000

% SOLUTION	Generally the additive to be dosed by the pump is part of an aqueous solution in a specified percentage. Set this value using the special arrow keys of the keyboard: 1 – 100 %
ml x m SET³	set the value in ml x m ³ which must be guaranteed in the plant. The permissible range is as follows: 0.1 – 50.000 ml x m ³

Proportional ppm (VFT-S, MF, VFT-S-T, MF-T)

For those who need a Parts per Million metering the PPM function has been provided: by setting the required parameters in the programming menu, the electronic system performs the necessary calculations and determines the type of intervention required to effect the pump. The parameters that must be defined are the following:

L / I METER	Sets the litres per impulse that are delivered by the meter used in the system, the expected types are as follows: 0.1 – 0.15 – 0.20 – 0.25 – 0.30 – 0.35 – 0.40 – 0.45 – 0.50 – 0.55 – 0.60 – 0.65 – 0.70 – 0.75 – 0.80 – 0.85 – 0.90 – 0.95 – 1 – 1.5 – 2 – 2.5 – 3 – 3.5 – 4 – 4.5 – 5 – 5.5 – 6 – 6.5 – 7 – 7.5 – 8 – 8.5 – 9 – 9.5 – 10 – 15 – 20 – 25 – 30 – 35 – 40 – 45 – 50 – 55 – 60 – 65 – 70 – 75 – 80 – 85 – 90 – 95 – 100 – 150 – 200 – 250 – 300 – 350 – 400 – 450 – 500 – 550 – 600 – 650 – 700 – 750 – 800 – 850 – 900 – 950 – 1000
--------------------	---

% SOLUTION	In many cases the additive to be dosed by the pump is part of an aqueous solution in a specified percentage. Set this value using the special arrow keys of the keyboard: 1 – 100 %
-------------------	---

PPM SET	Set the value in p.p.m. (Parts Per Million) that the plant must guarantee. The permissible range is as follows: 0.1 – 50.000 ppm
----------------	--

Proportional mA (VFT-S, MF, VFT-S-T, MF-T)

The pump is equipped with a current input. It receives a signal that is between 0 and 20 mA and delivers a series of injections proportional to the signal received.

The parameters to set are the following:

Setting mA (1) SET 1:	mA value at the set point 1, through the definition of SET 1 we establish the value in mA from which we want to start the metering. Default Value - 4.0 mA.
Setting mA (2) SET 2:	mA value at the set point 2, through the definition of SET 2 we establish the value in mA from which we want to start the metering. Default Value - 20.00 mA.
Impulses/minute (1) SET 1:	The pump automatically changes the frequency of injections between the two set points previously set (SET1 - SET2). The user has the option to define the number of impulses per minute, corresponding to the value in mA set in SET1: Default Value 0 imp/min.
Impulses/minute (2) SET 2:	The user can define the number of impulses per minute corresponding to the maximum metering peak: the largest selectable value must be greater than that set on the SET1 but may not go beyond the maximum frequency of impulses per minute that can be delivered by the pump.
Under mA (1) SET 1:	In relation to the system requirements, the pump allows you to determine whether to continue or terminate the metering when the measurement takes on a current value below the set point 1 (SET1).
Above mA (2) SET 2:	In relation to the system requirements, you can define whether to continue or terminate the metering when the measurement has a current value above the set point 2 (SET2).

OPERATING FUNCTIONS DIAGRAMS OF THE PLUS "PROPORTIONAL" PUMP

Flow Diagram main menu

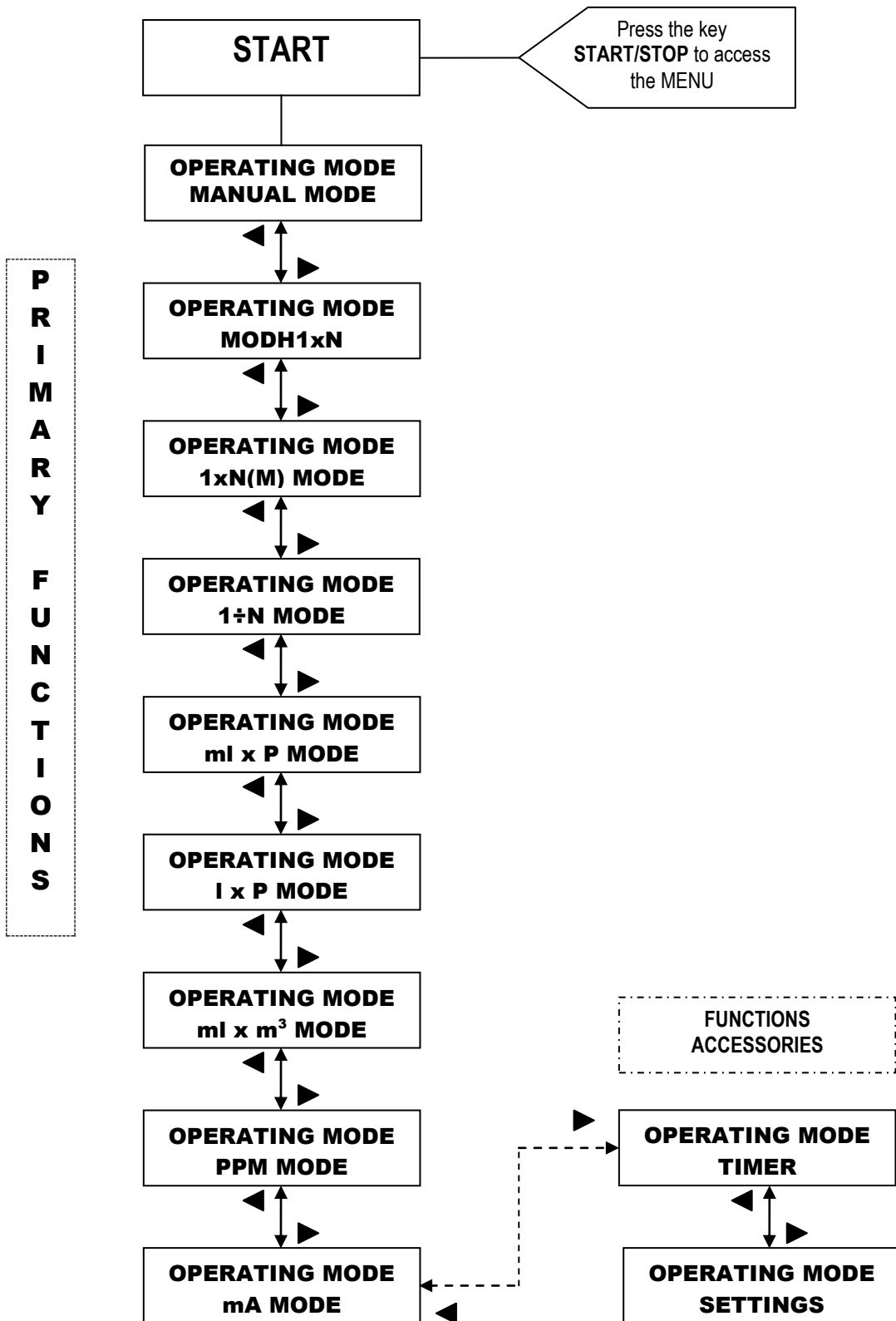

Flow Diagram Manual mode

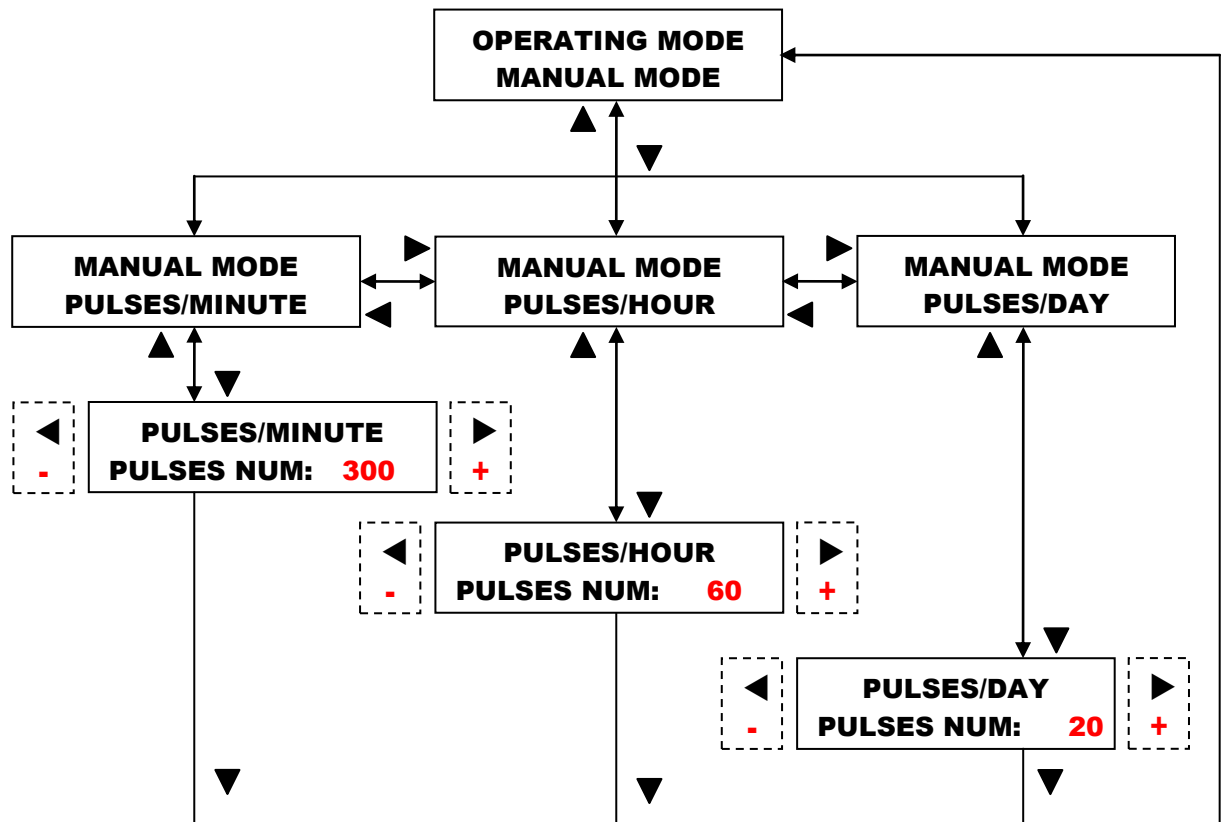

Flow Diagram 1xN mode

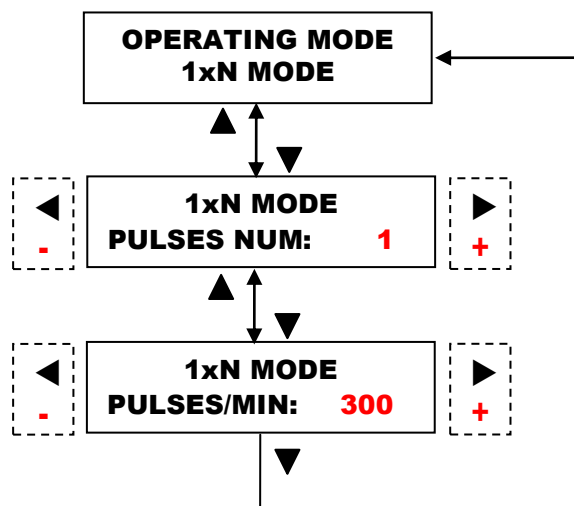

Flow Diagram 1xN(M) mode

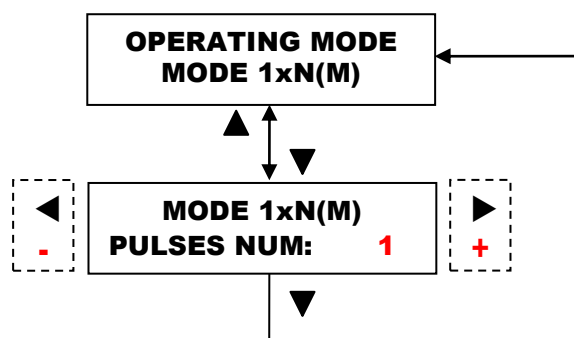

Flow Diagram 1 ÷ N mode

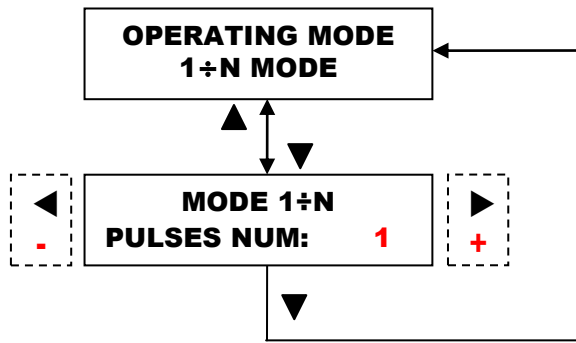

Flow Diagram ml x P mode

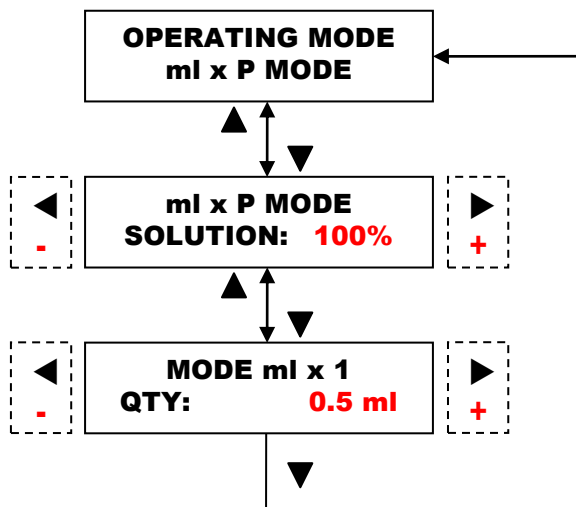

Flow Diagram l x P mode

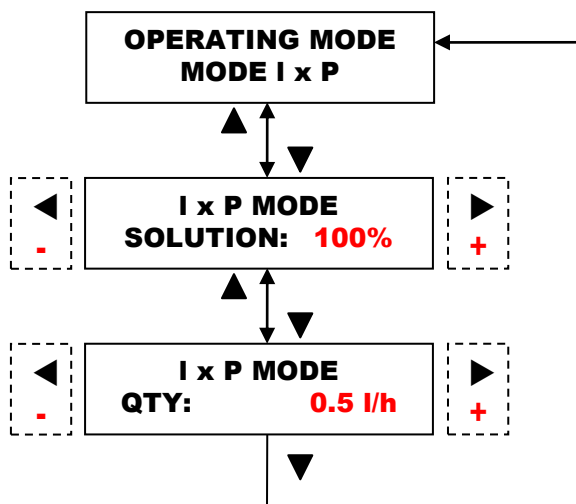

Flow Diagram ml x m³ mode

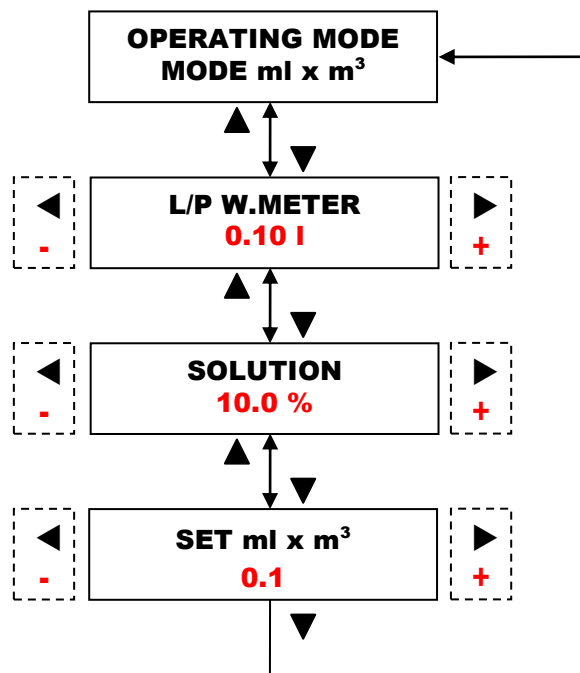

Flow Diagram PPM mode

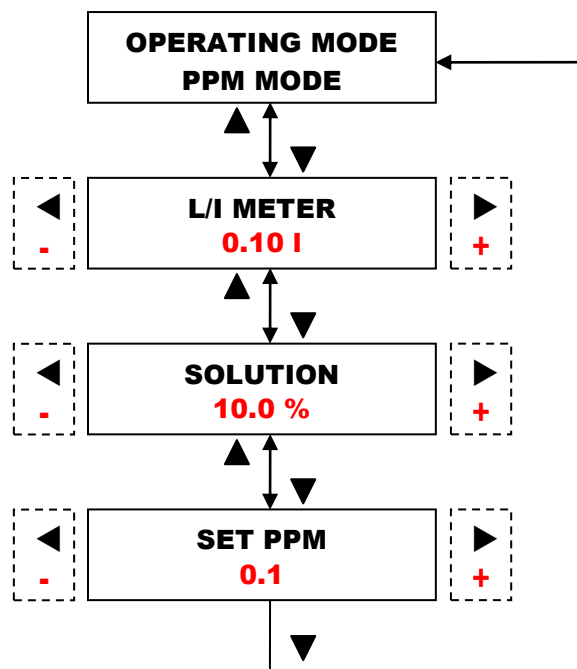

Flow Diagram mA mode

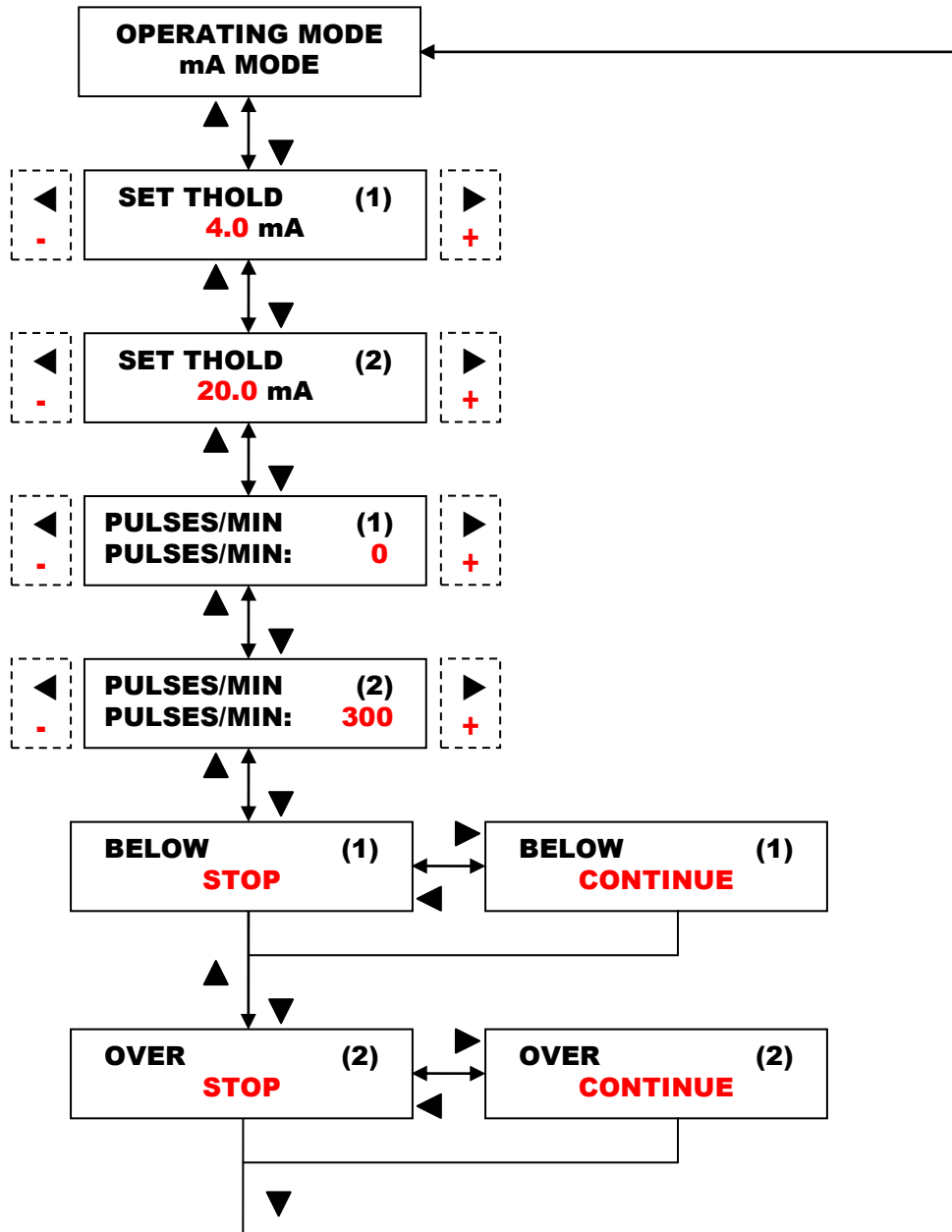

OPERATIONAL FUNCTIONS OF THE PLUS "METERING" PUMP



Selecting the configurations: ST and ST-T, the metering pump is placed in the control mode and in function of the electrochemical parameter type selected (pH, RX, ppm Cl, ppm), it intervenes maintaining the correct set value. Once the instrument configuration is set, you must select one of the following operating modes:

- Manual
- pH mode
- RX mode
- Cl mode
- ppm Mode

The pump instrument operates within the following measurement ranges:

- pH measurement 0,00 ÷ 14,00
- RX measurement -1000 ÷ +1400 mV
- Cl measurement 0 ÷ 2, 0 ÷ 10, 0 ÷ 20, 0 ÷ 200 ppm
- ppm measurement 0 ÷ 2, 0 ÷ 10, 0 ÷ 20, 0 ÷ 200
- Temperature measurement 0 ÷ 100 °C (PT100)

Manual

Mode of operation similar to that described in the "proportional" version.

pH mode

In pH mode, the pump must be connected to a pH sensor and through the proper configuration of the setup menu. The device is responsible for ensuring the maintenance of the set-point value and the management of all the devices connected to the pump terminal box.

The pump offsets the displayed value in reference to the value of the measured temperature (PT100) or as reference it uses the value set manually by the user.

In the configuration menu of the pH mode you can carry out the following settings:

- Setpoint Configuration.
- Probe Configuration.
- Temperature value Setting (present if the MANUAL mode is enabled).
- Current Output Setting

Sensors made from either glass or plastic material can be used. Connect the probe as shown in Fig. 10

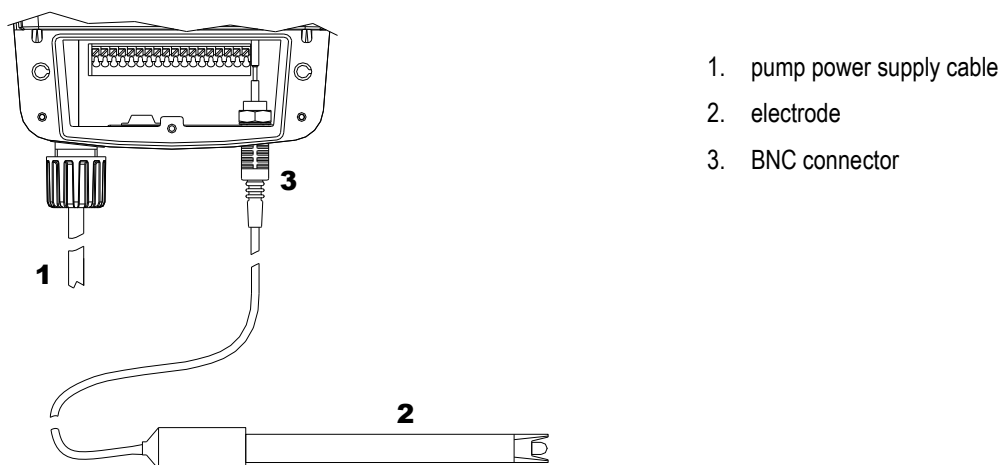

Fig. 10 – Electrodes connection pH and REDOX

RX mode

In RX mode, the pump must be connected to a RX sensor and through the proper configuration of the setup menu. The device is responsible for ensuring the maintenance of the set-point value and the management of all the devices connected to the pump terminal box.

In the configuration menu of the RX mode you can carry out the following settings:

- Setpoint Configuration.
- Probe Configuration.
- Temperature setting (present if the MANUAL mode is enabled).
- Current Output Setting

Sensors made from glass or plastic material can be used, connect the probe as shown in fig. 10.

CI mode

In CI mode, the pump must be connected to a CI sensor such as a potentiometer and through the proper configuration of the setup menu. The device is responsible for ensuring the maintenance of the set-point value and the management of all the devices connected to the pump terminal box. The chlorine probe can be connected to the pump using the dedicated cable: when the BNC is connected, the remaining two cables must be inserted into the cable sleeve and connected to the "inputs" terminal of the pump (see Figure 11).

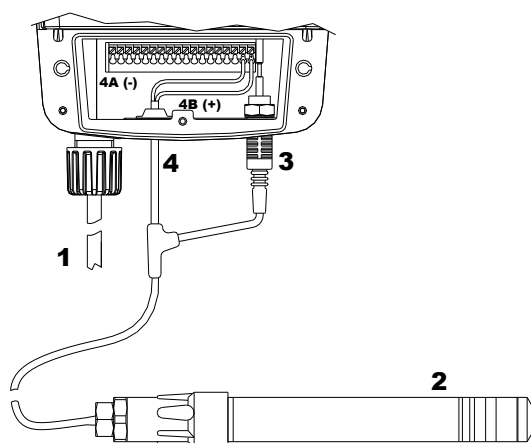

1. Pump power supply cable
2. CL probe
3. BNC Connector CL Probe
4. Power supply cable CL probe

Connect the power supply cables of the probe to terminals 17 (4A- negative - white) and 18 (4B – positive - brown) of the terminal board.

Fig. 11 – Connection CI (ppm) and PPM probes

In the configuration menu of the CI (ppm) mode you can carry out the following settings:

- Setpoint Configuration.
- Probe Configuration.
- Temperature setting (present if the MANUAL mode is enabled).
- Current Output Setting

ppm mode

In ppm mode, the pump must be connected to a sensor such as a potentiometer in order to control certain chemicals. By means of the proper configuration of the setup menu, the device is responsible for ensuring the maintenance of the set-point value and the management of all the devices connected to the pump terminal box.

The probe for controlling certain chemical species can be connected to the pump using the dedicated cable: when the BNC is connected, the remaining two cables must be inserted into the cable sleeve and connected to the "inputs" terminal of the pump (see Figure 10).

In the Etatron list you can check the availability of the different types of sensors. The probes for chemical species are connected to the pump as shown in fig. 11

In the configuration menu of the PPM mode you can carry out the following settings:

- Setpoint Configuration.
- Probe Configuration.
- Temperature setting (present if the MANUAL mode is enabled).
- Current Output Setting

OPERATING FUNCTIONS DIAGRAMS OF THE PLUS "METERING" PUMP

Flow Diagram main menu

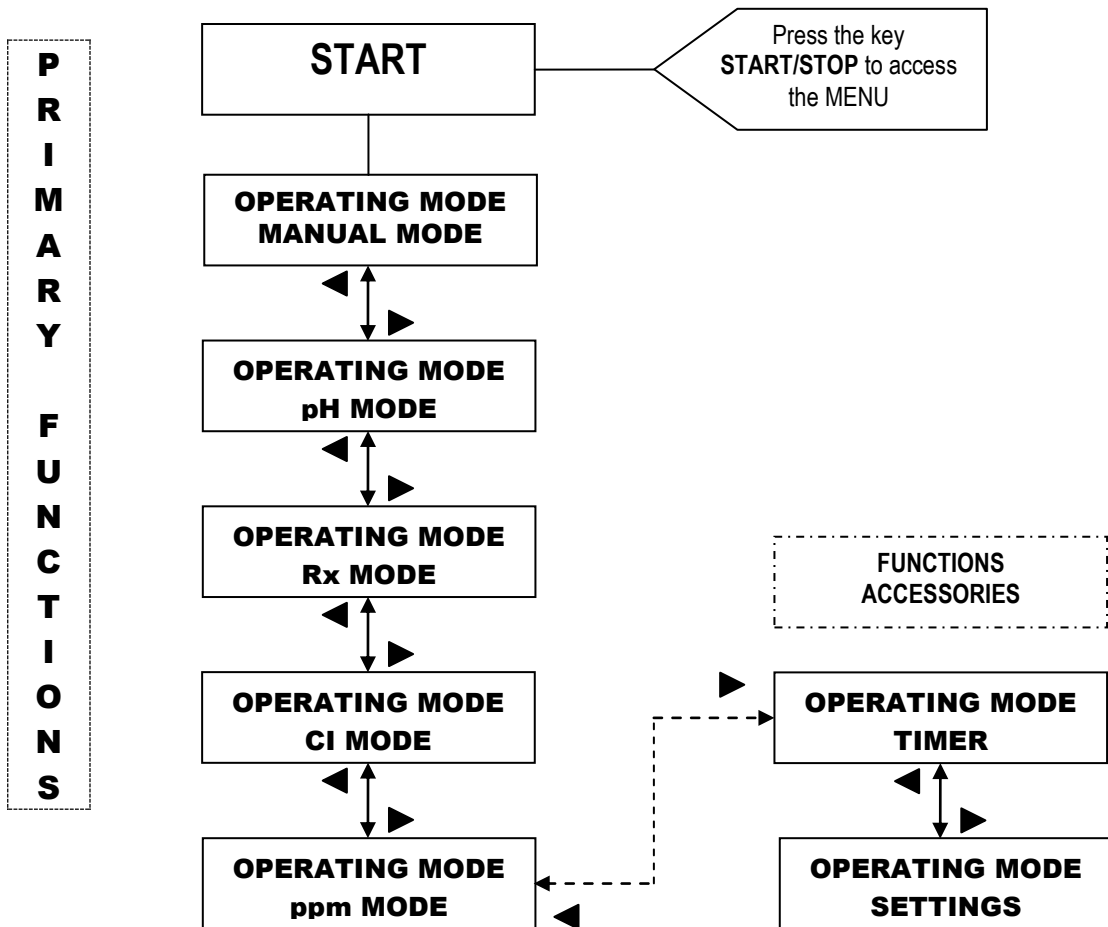

Flow diagram PH mode

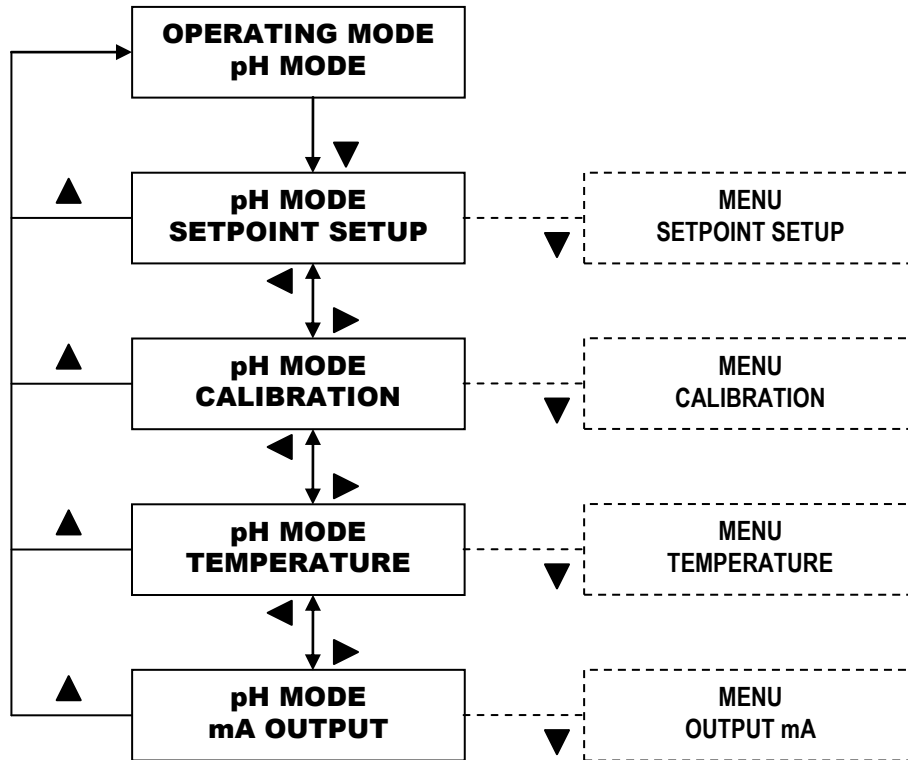

Flow diagrams pH mode submenu

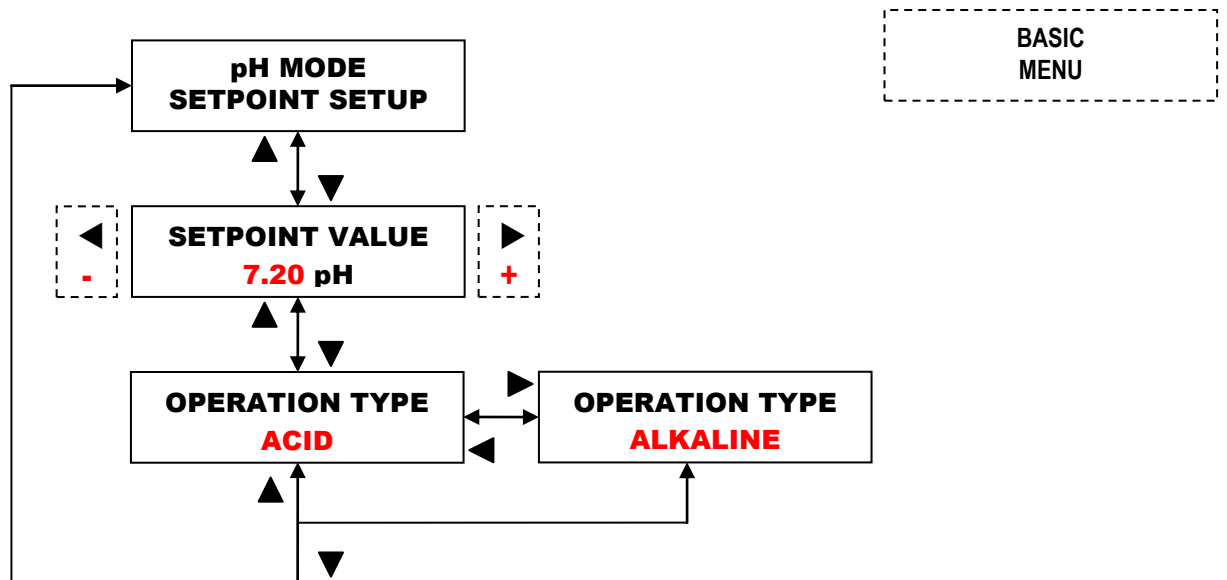

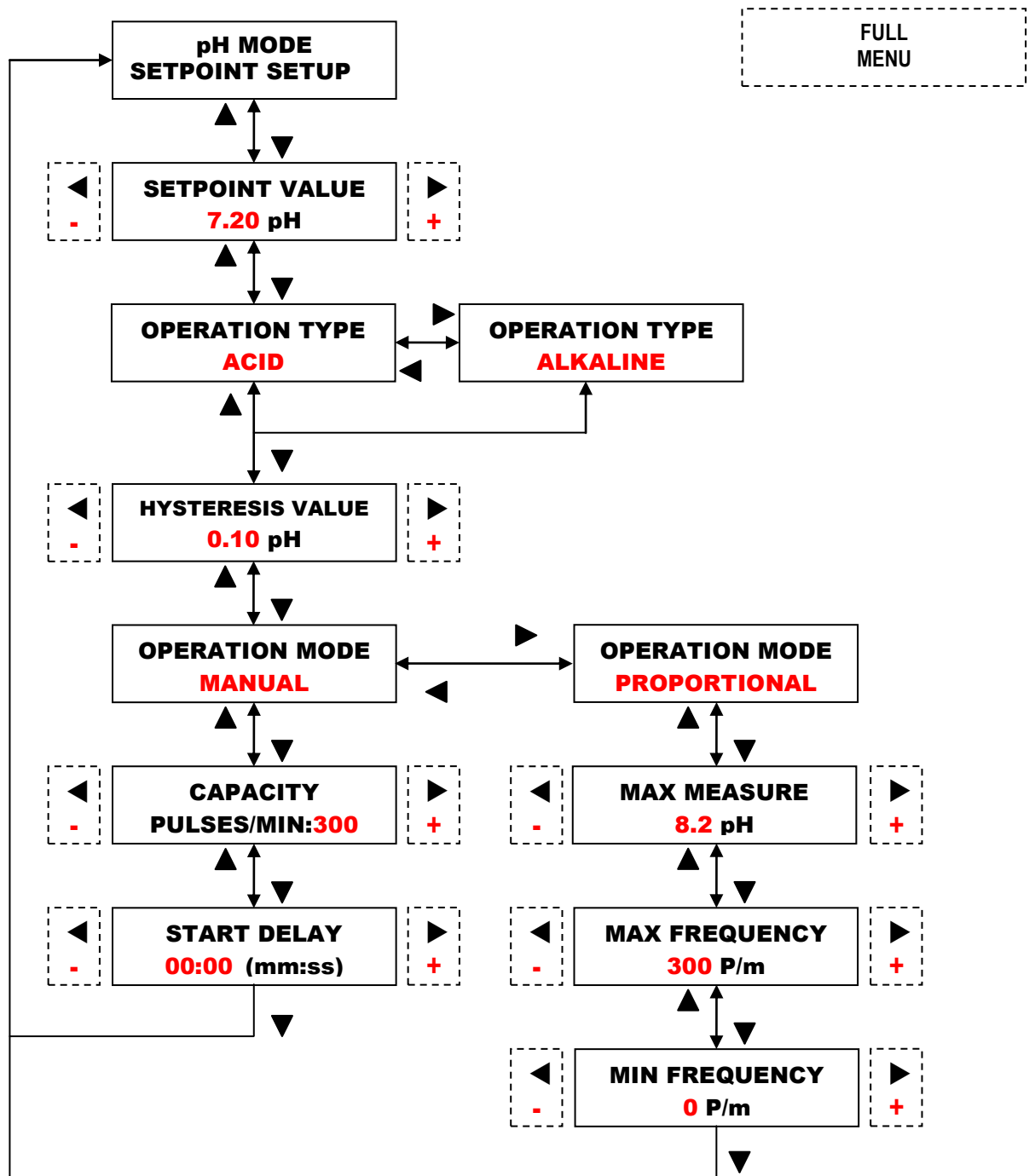

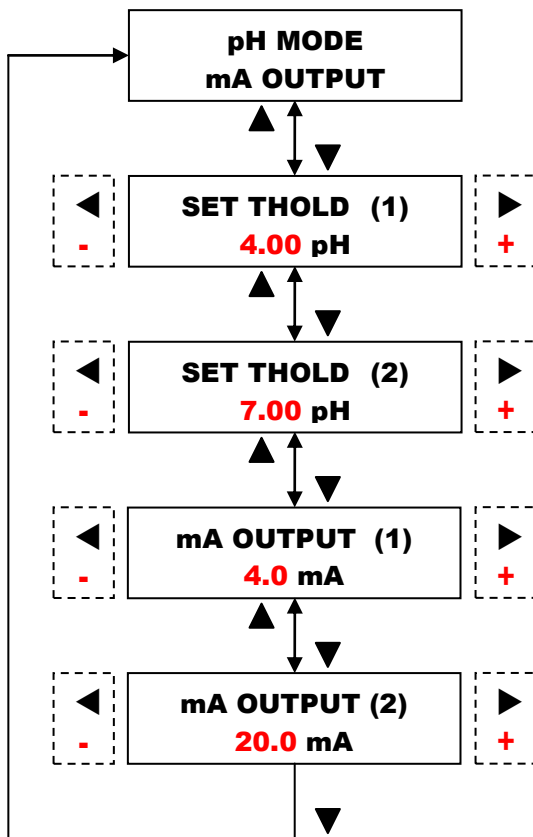
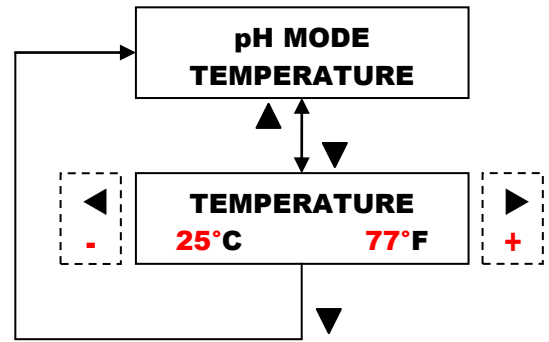
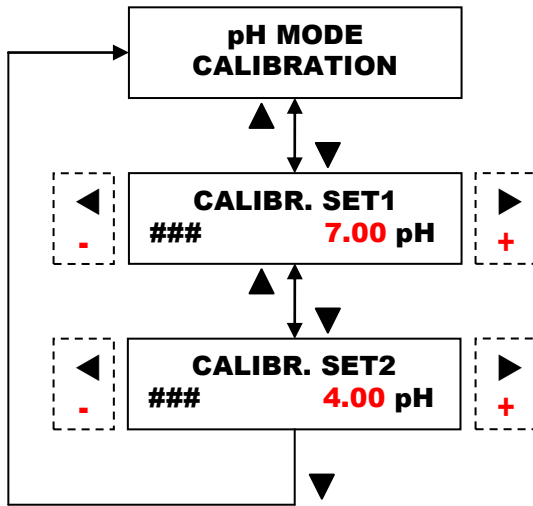

Flow diagram RX mode

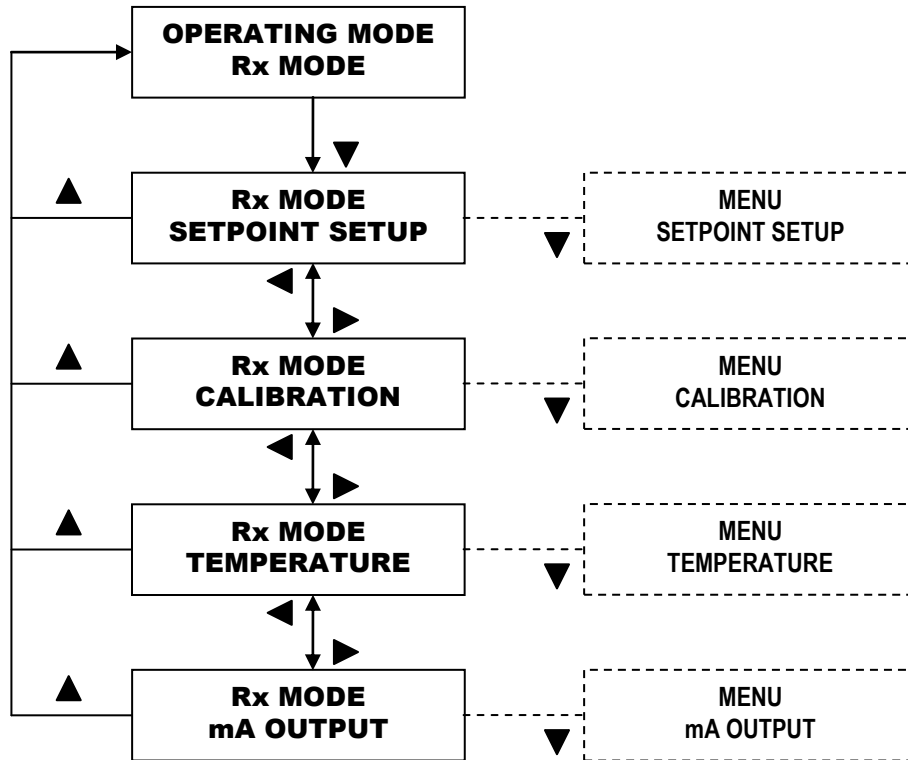

Flow diagrams RX mode submenu

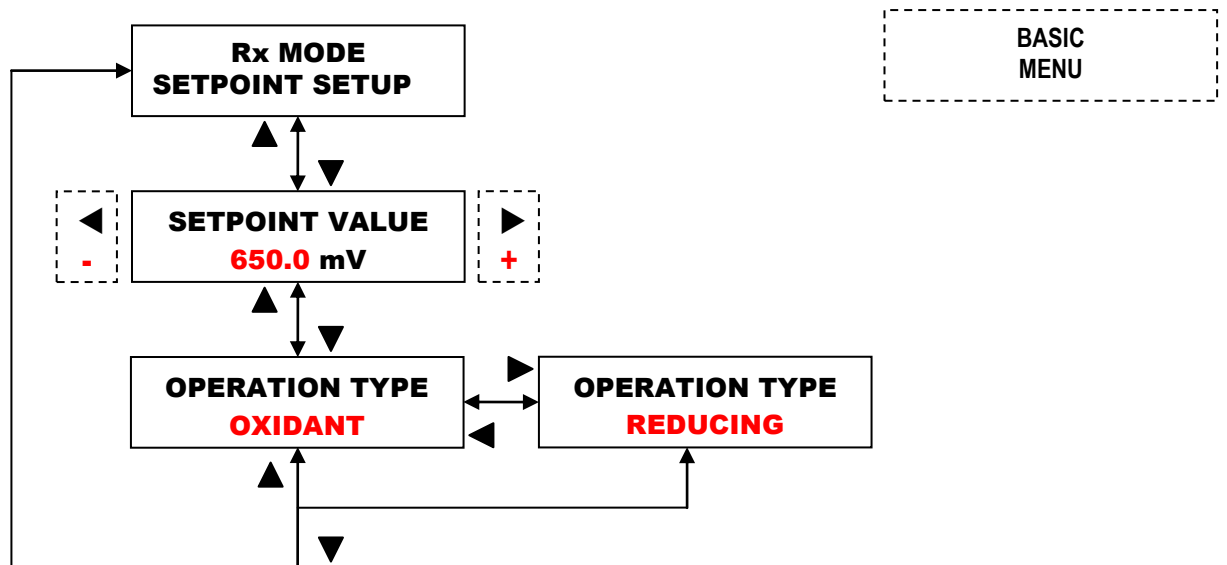

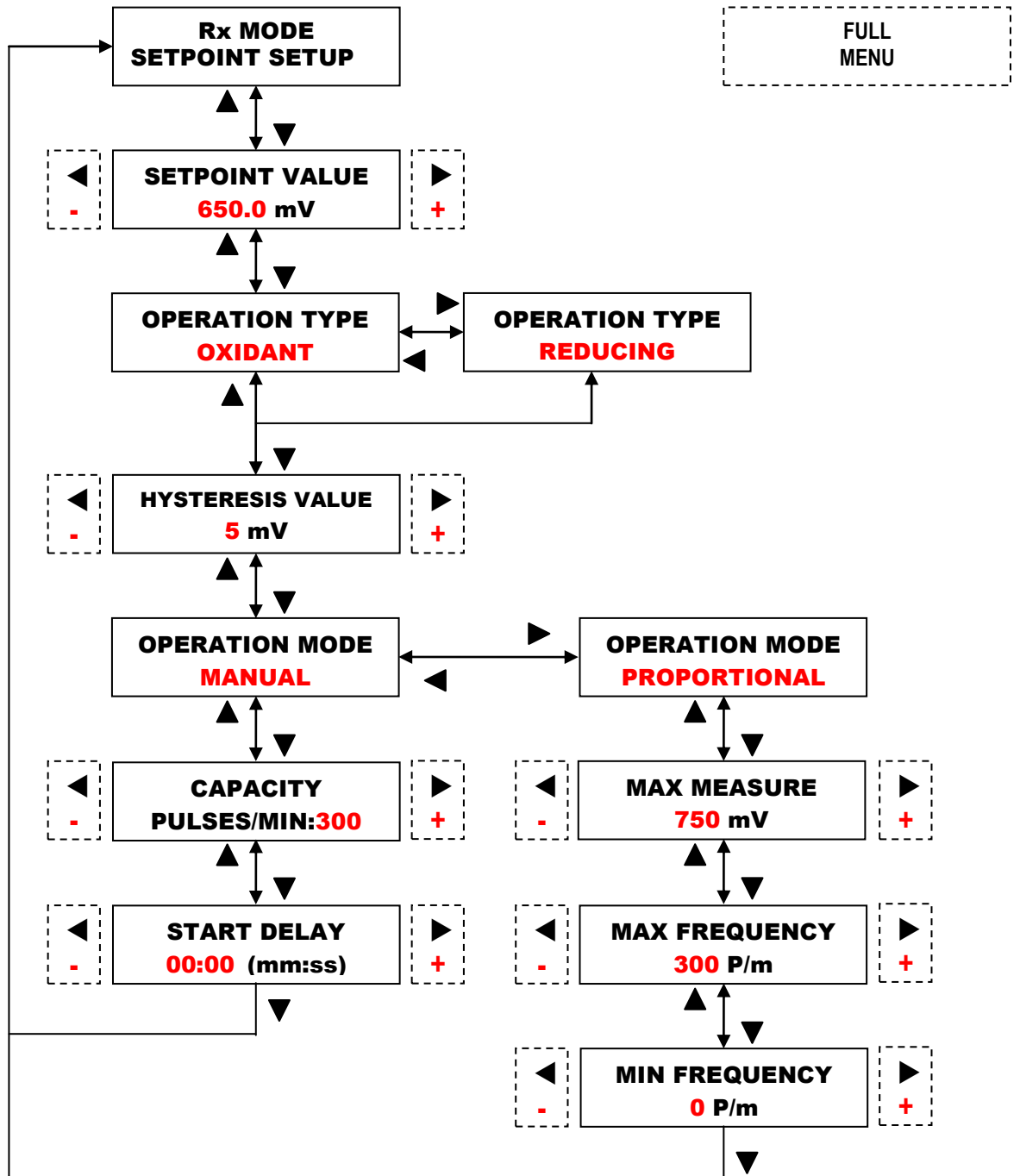

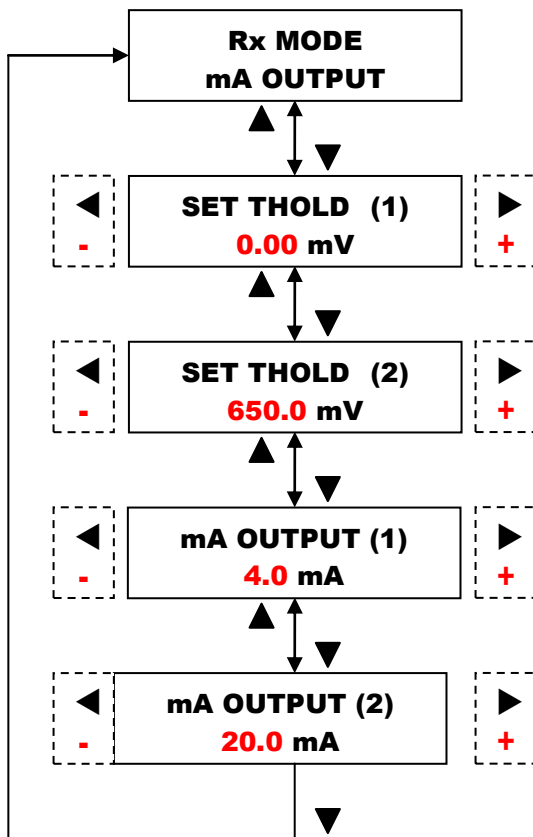
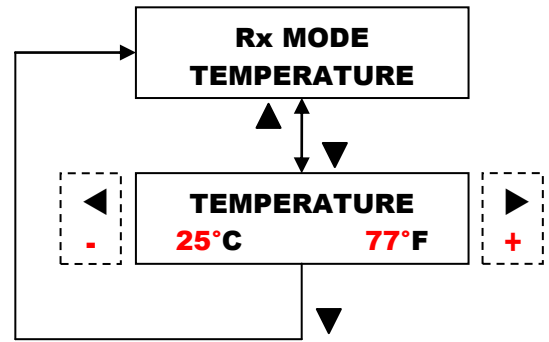
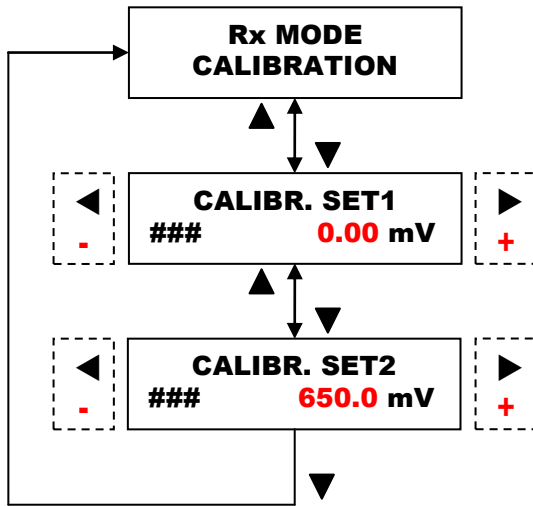

Flow diagram CL mode

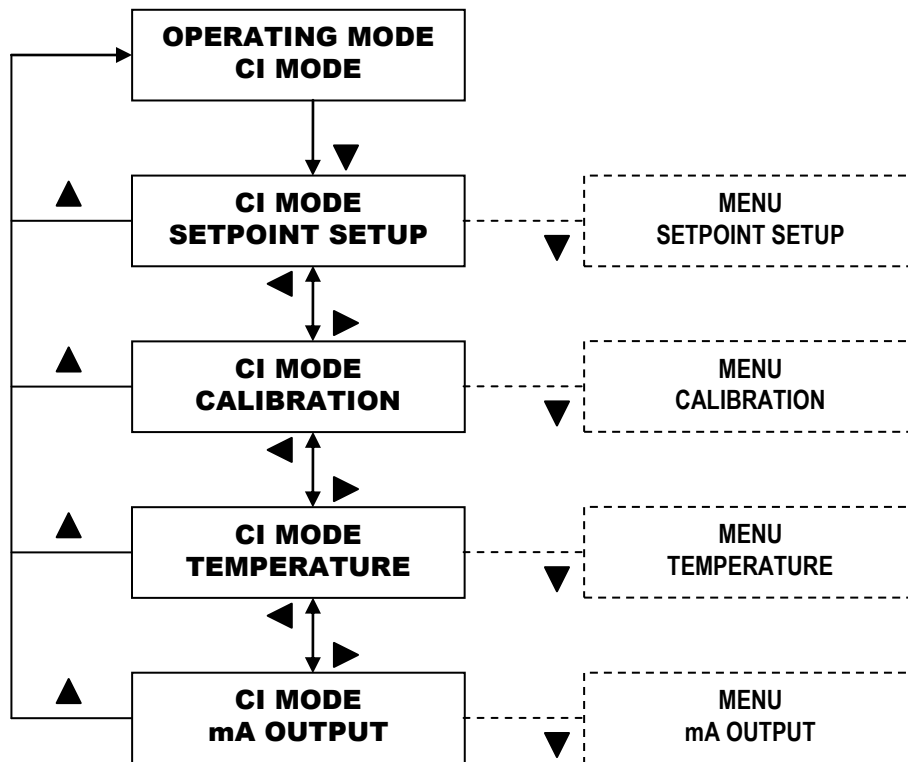

Flow diagrams CL mode submenu

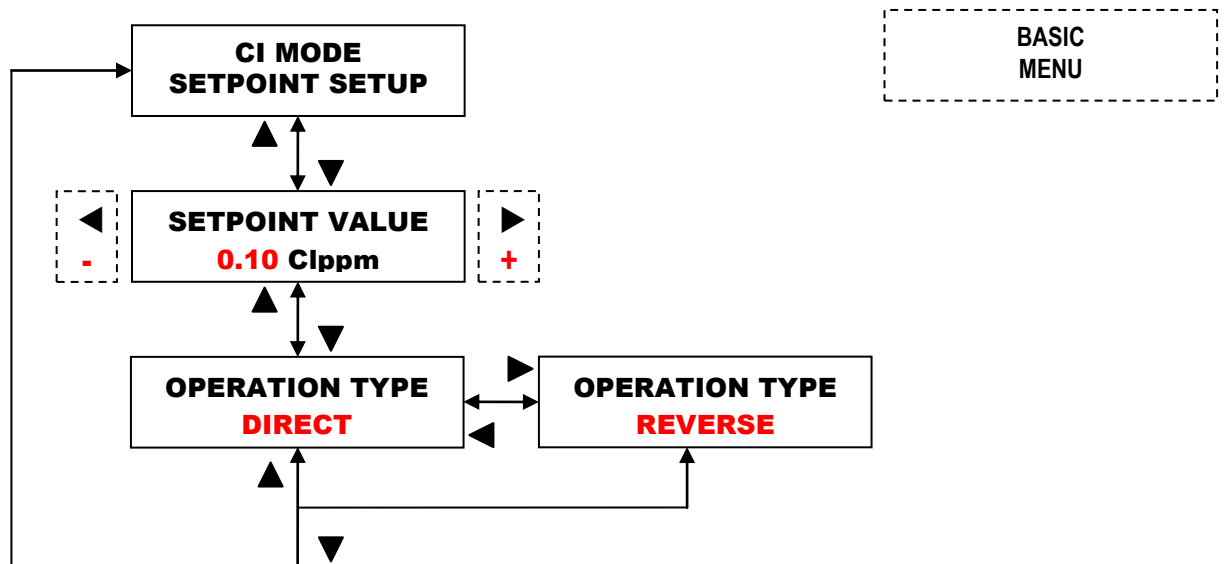

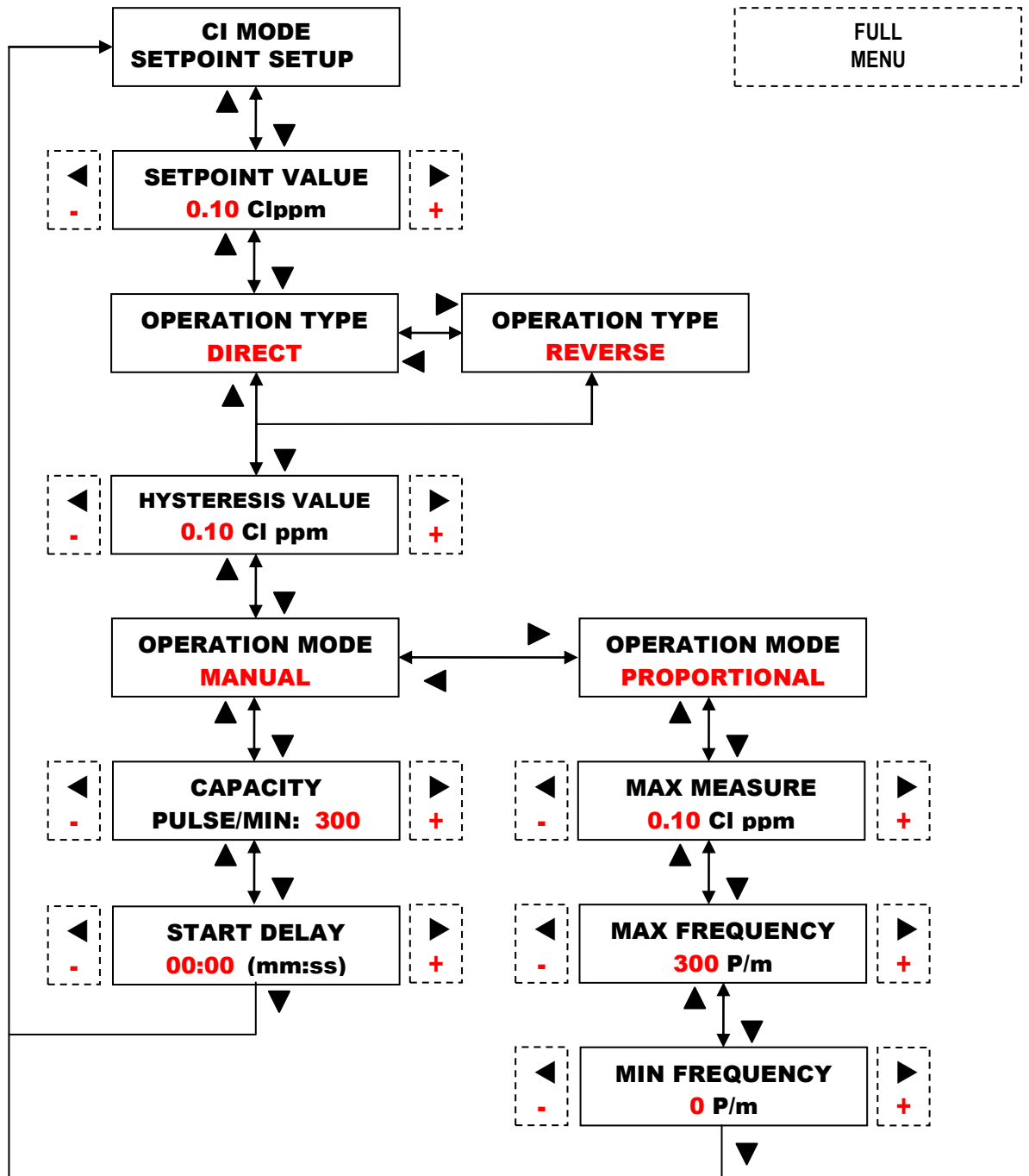

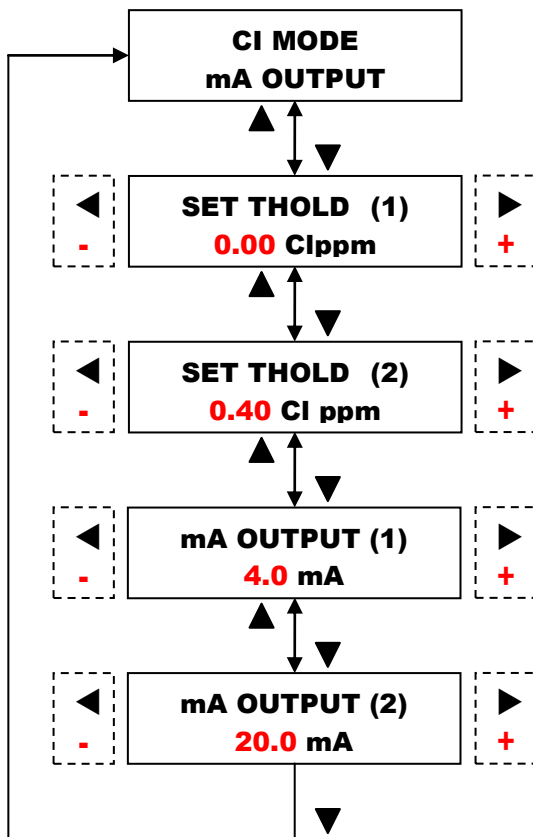
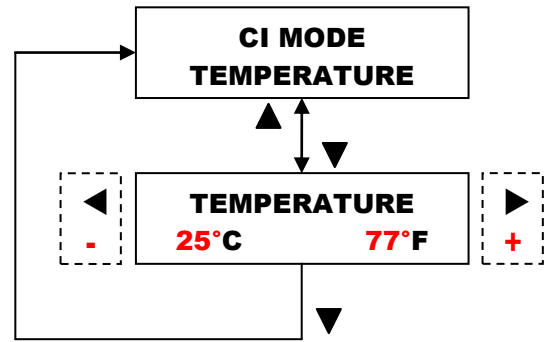
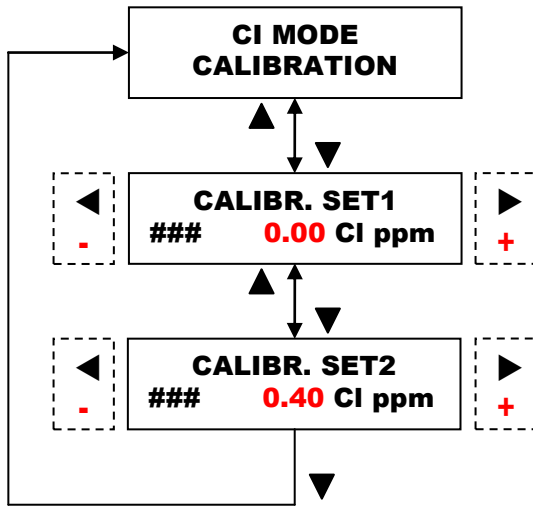

Flow diagram ppm mode

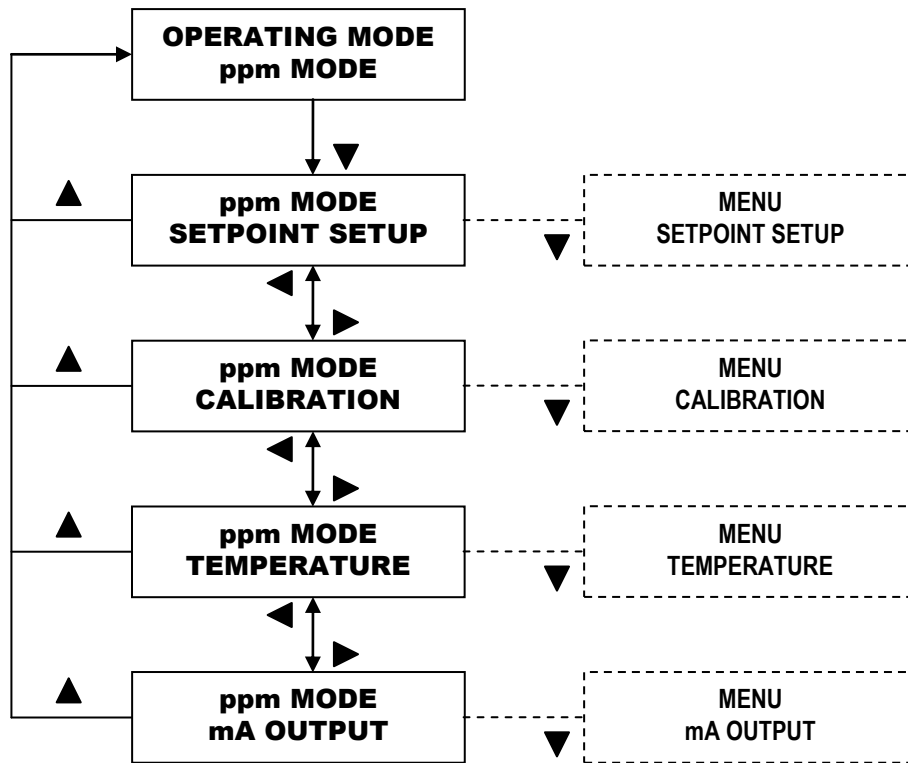

Flow diagrams ppm mode submenu

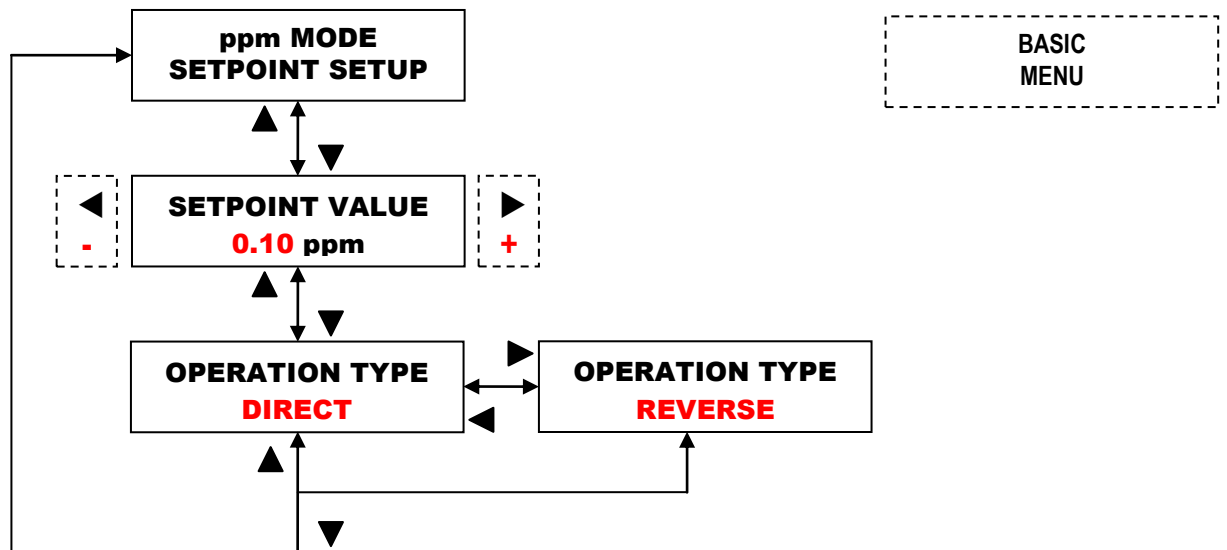

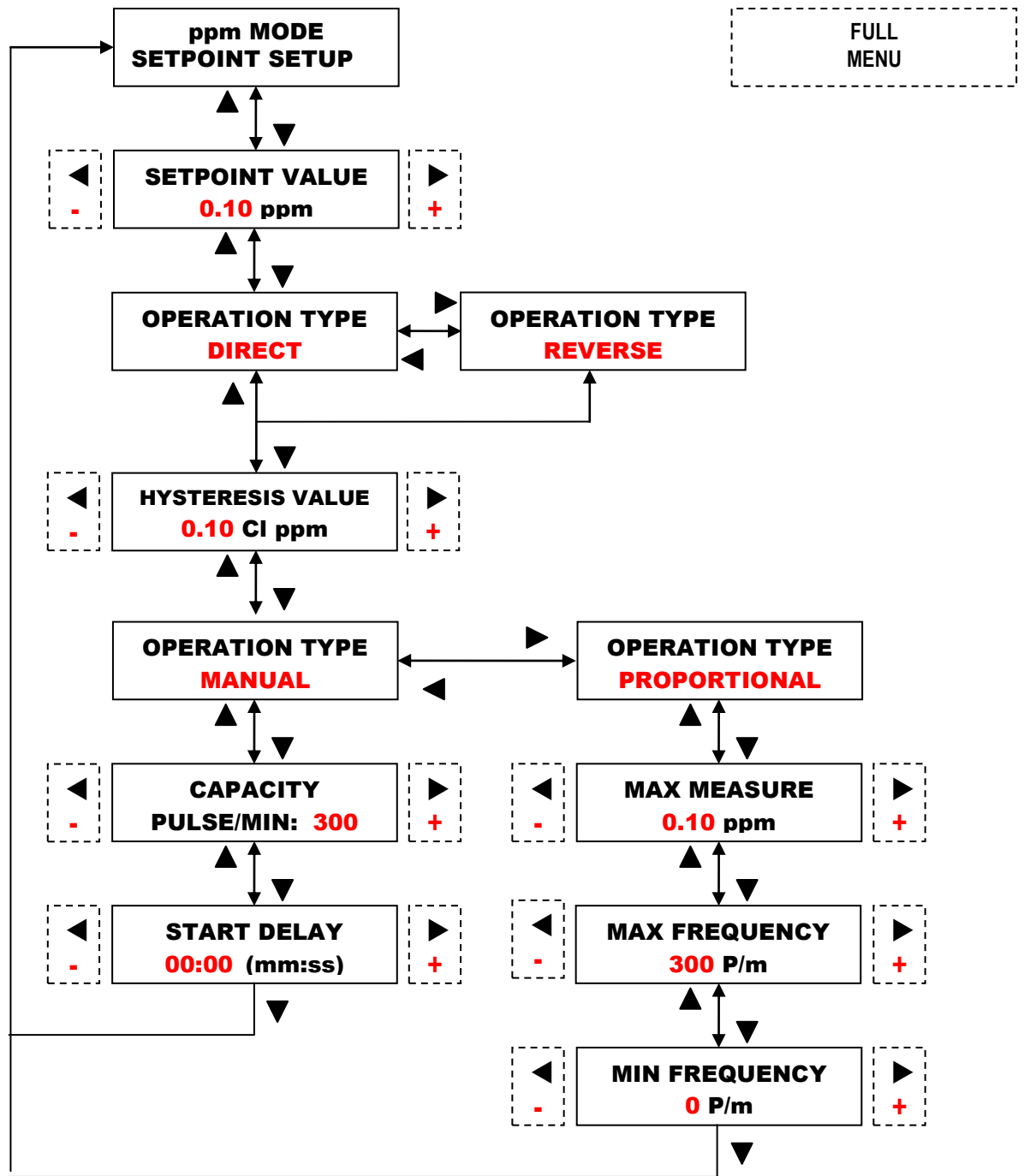

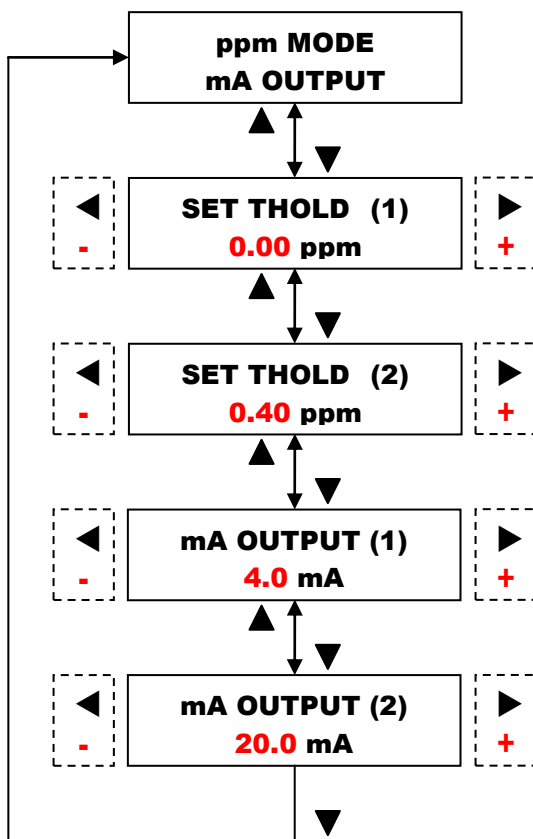
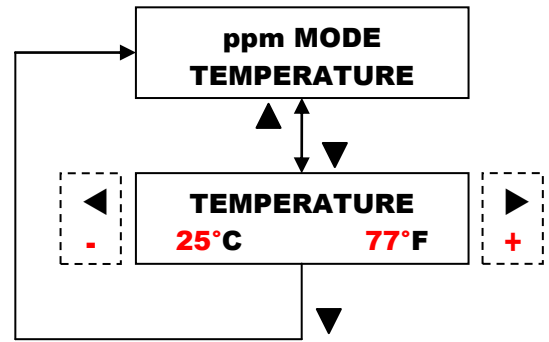
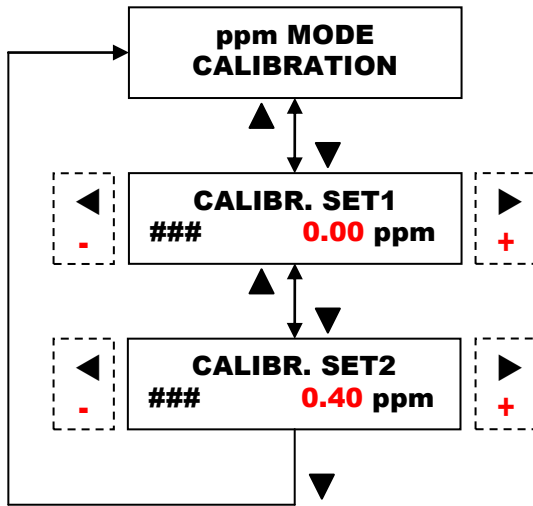

FUNCTIONS ACCESSORIES OF THE PLUS PUMP



In order to facilitate the consultation of this manual, the configuration with the function described is shown in the subsection titles. Nothing is specified when the function is common to all versions.

Remote Control - Level - Proximity (Instrument versions only)

Remote control means the ability to remotely control any device by means of a cable, in our case bipolar; which means that through the opening and closing of a contact, placed at a maximum distance of 100 metres, we can enable or disable the delivery of the impulses generated by the electronic circuit. You can choose between two different operation modes from the menu:

DIRECT Contact open pump operating, contact closed pump in stand-by.

REVERSE Contact open pump in stand-by, contact closed pump operating.

By connecting a floating sensor to the connector of the remote control you can control the level of the additive metered by the pump.

In the case of the control pump, it is possible to activate the input for connection to the proximity sensor which detects the passage of the flow in the probe holder and enables the operation of the pump.

Flow rate per impulse (proportional versions only)

For accurate metering in the eOne Plus pump the option to both manually and automatically set the flow rate for each injection has been implemented by starting the procedure laid down in the appropriate configuration menu, in this case, the electronic device, performs independently the necessary calculations for the proper calibration of the injection.

Setting the maximum frequency

Depending on the model the metering pump exits from the production line with a specific maximum injection frequency, if necessary, the user can change this parameter by lowering or restoring it in accordance with the needs of the plant to be treated.

PPM Scale setting

Depending on the type of probe installed, you can select the measurement scale, the ranges available are the following:

- 0 ÷ 2 ppm
- 0 ÷ 10 ppm
- 0 ÷ 20 ppm
- 0 ÷ 200 ppm

This setting is valid in both the PPM and CI configuration.

Alarms

See the next chapter for a detailed description of the different alarms available.

Clock

In some applications, there may be the need to program the activation or deactivation of the pump, which is why the electronic device is equipped with a clock and calendar. The following settings can be carried out:

CLOCK hh:mm – Day (Hour:minutes – MON/TUES/WED/THU/FRI/SAT/SUN)
DATE Day/Month/Year.

During normal operation of the pump the time will always be present on the display.

Password

By means of enabling and setting the 4-digit password, the user can protect the device and prevent access to the programming menus by unauthorized personnel.

Temperature (Instrument versions only)

It is possible to select one of the following operational modes:

- **MANUAL** – the value set in the configuration menu by the user, is the reference parameter for the compensation of the pH value.
- **AUTOMATIC** - The value measured by the probe is the reference parameter for the compensation of the Ph value. In the menu "MODE PH, RX, CL, PPM" the "TEMP" menu appears.

Activation delay (Instrument versions only)

If there is a need to delay the operation of the pump you can set a delay in the following time in the following scale:
0" ÷ 60'

Mode menu (Instrument versions only)

In order to simplify the definition of the various functions we have introduced two selections that allow you to modify the complexity level of the programming:

- **FULL** - All functions are available.
- **BASIC** - Only the main functions are available.

You can set a time after which the display will automatically exit the programming menu. The default time is 2'.

Language

You can select one of the following languages for the display messages.

- Italian
- English

Reset

The device is equipped with two reset levels, the user can choose between the following two possibilities:

- **PARTIAL RESET** - The pump remains in the selected operating mode (proportional or control), but all factory settings are restored and all user settings deleted.
- **TOTAL RESET** - The pump returns to its factory settings, at reboot you will need to set the operating mode you want to activate: VFT, VFT-S, MF, ST, VFT-T, VFT-S-T, MF-T, ST-T, as per the table.

FLOW DIAGRAM SETTINGS MENU



Some menu items are only present in the proportional or control versions, as shown in the box next to the blocks. To access the items of the Setting Submenus press the button ▼

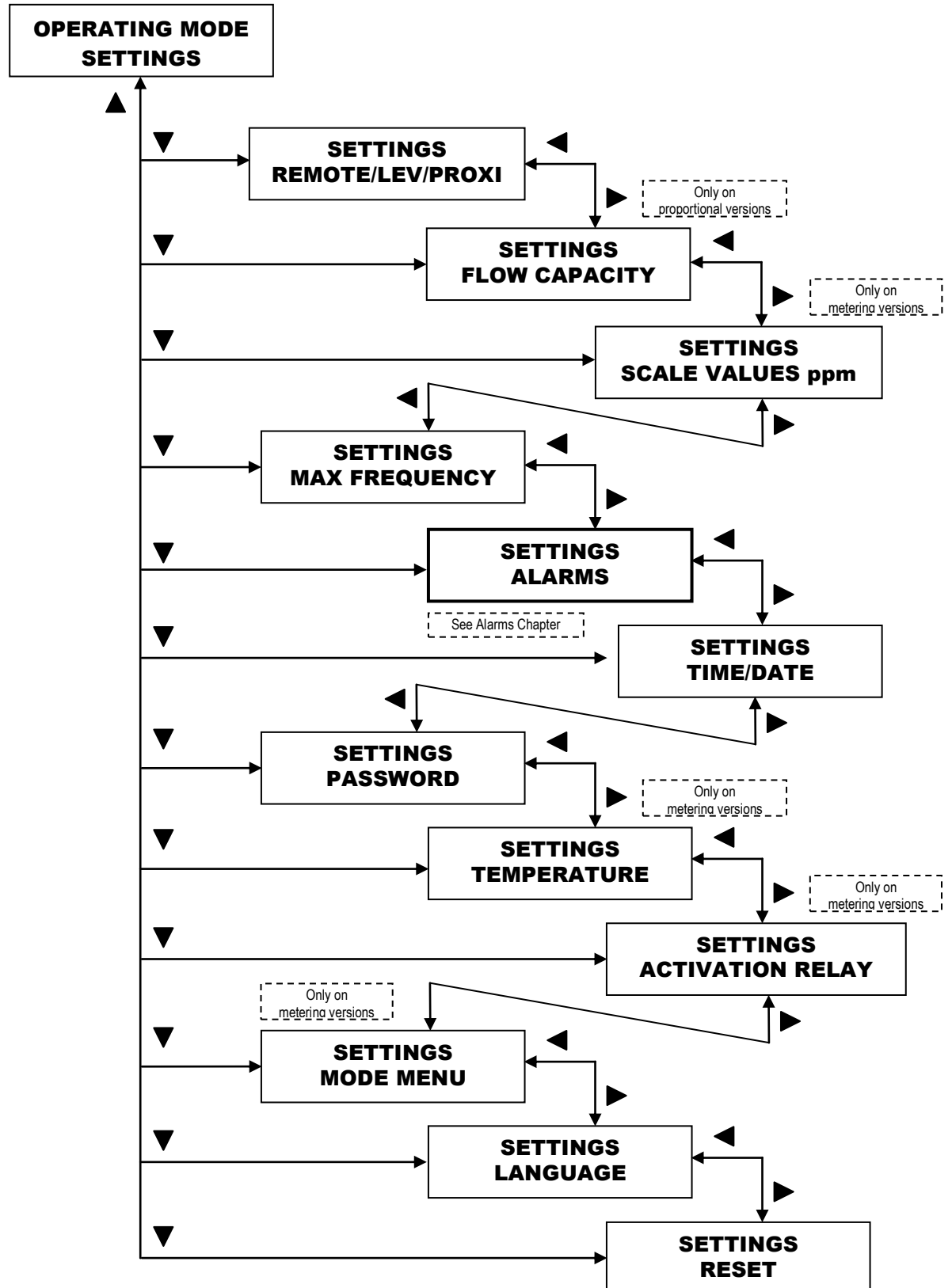

Flow diagram submenu REMOTE CONTROL/LEVEL/PROXIMITY

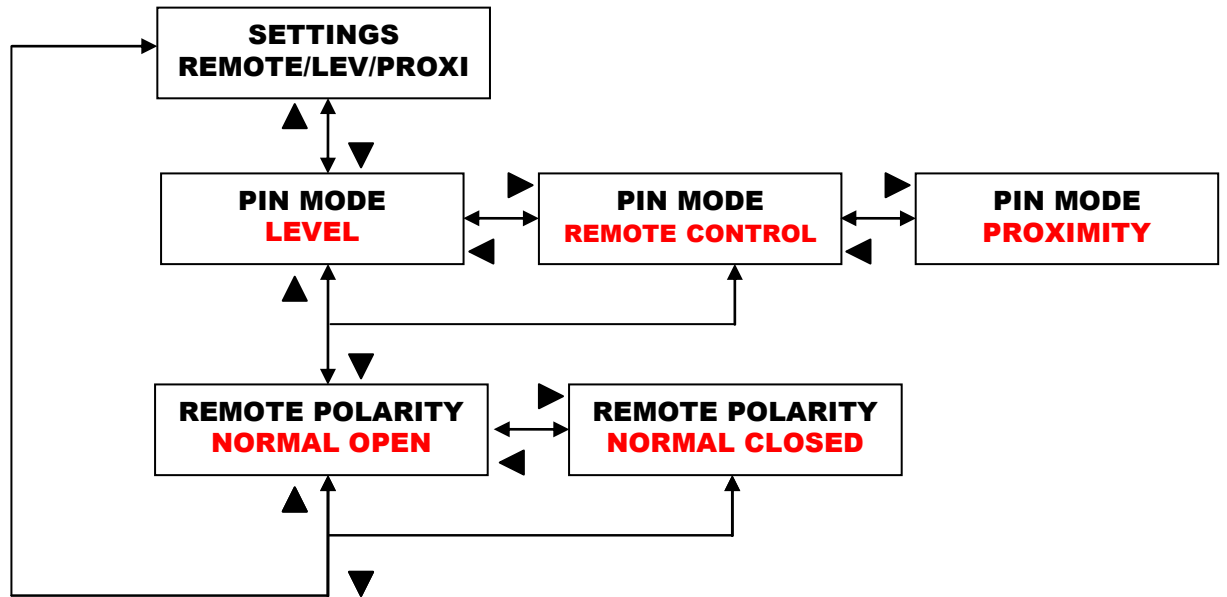

Flow diagram submenu FLOW RATE PER IMPULSE (only proportional versions)

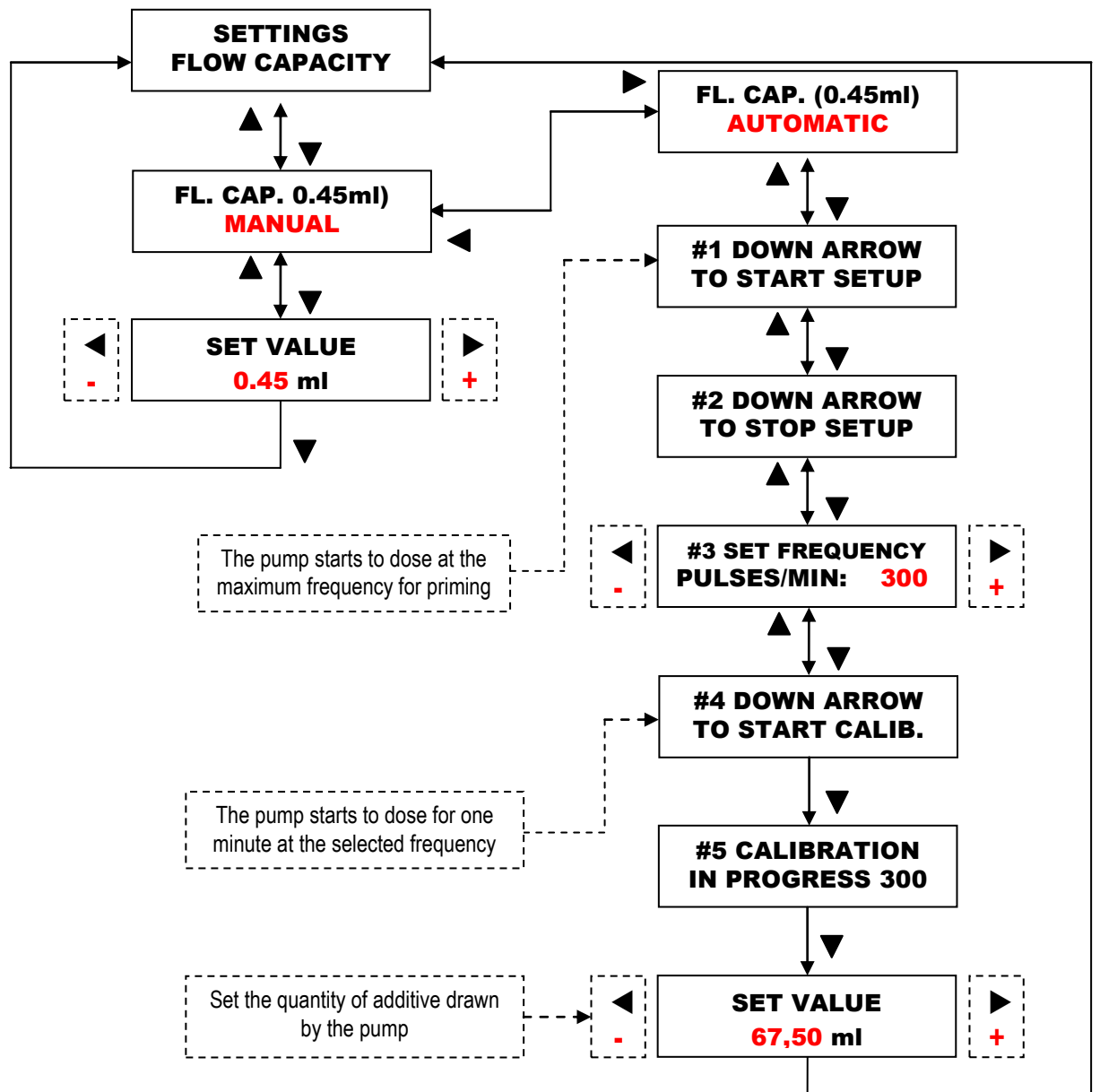

Flow diagram submenu PPM SCALE VALUES (only metering versions)

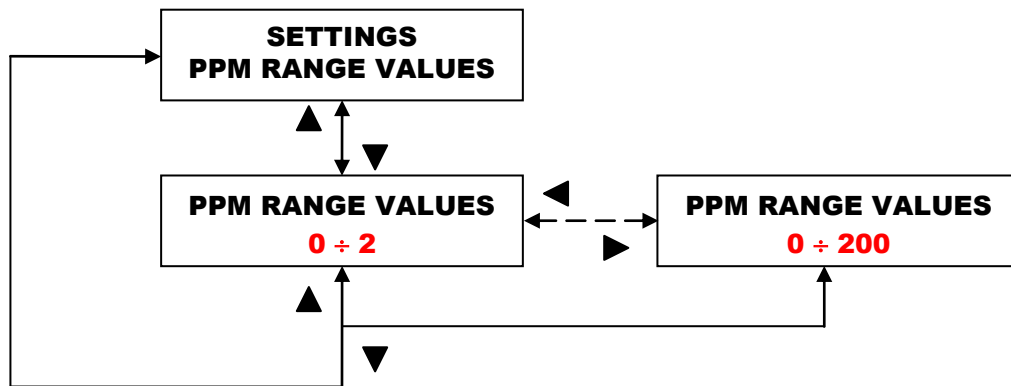

Flow diagram submenu MAXIMUM FREQUENCY

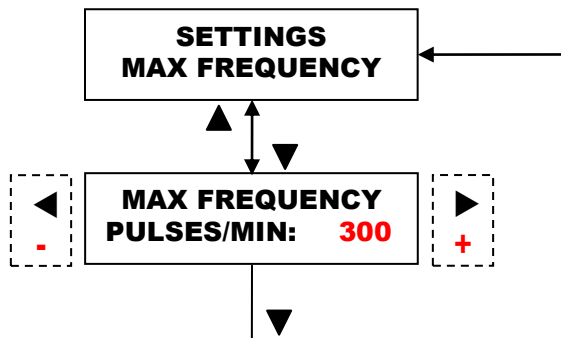

Flow diagram alarm settings submenu

See Alarms Chapter

Flow diagram CLOCK submenu

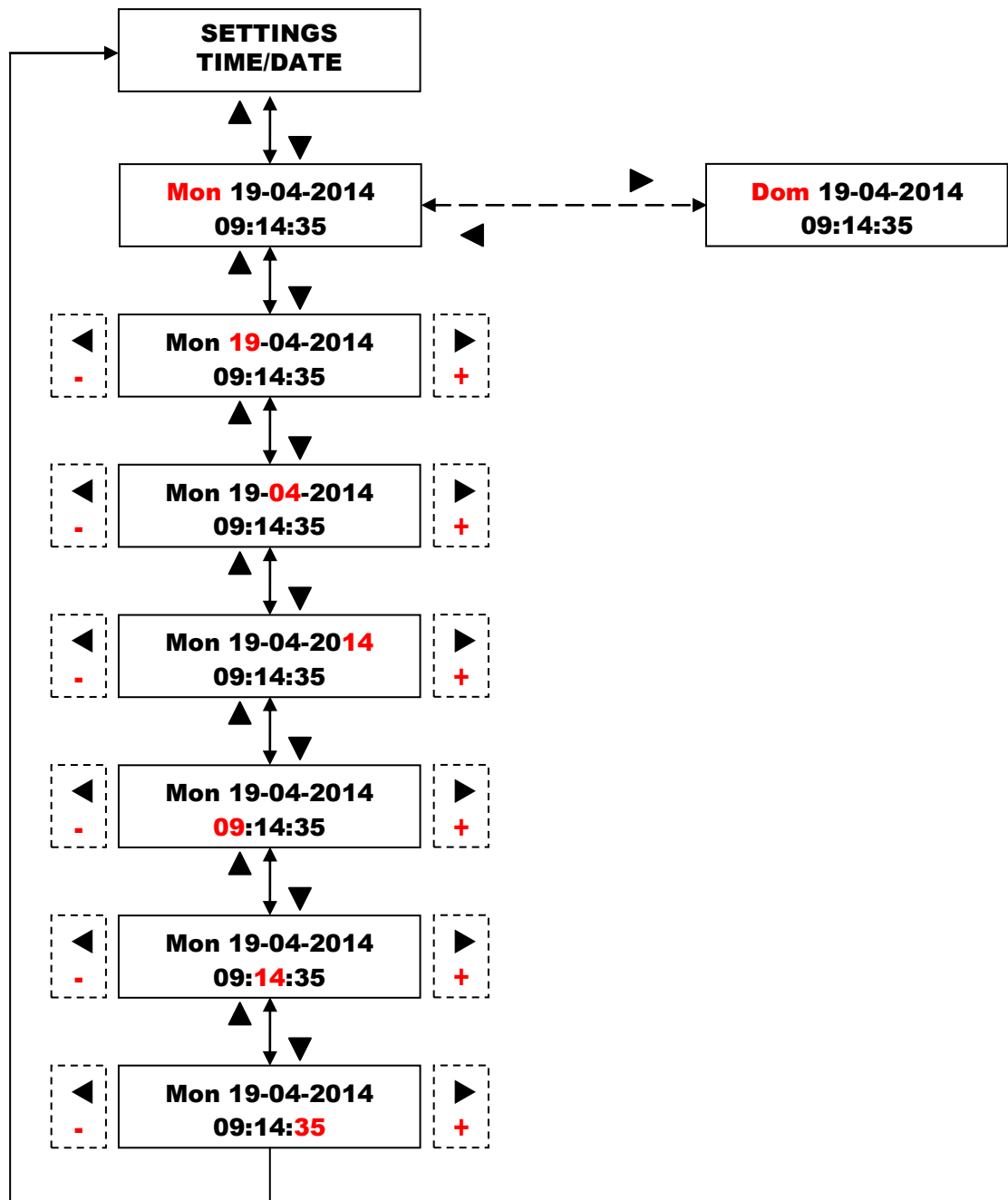

Flow diagram PASSWORD submenu

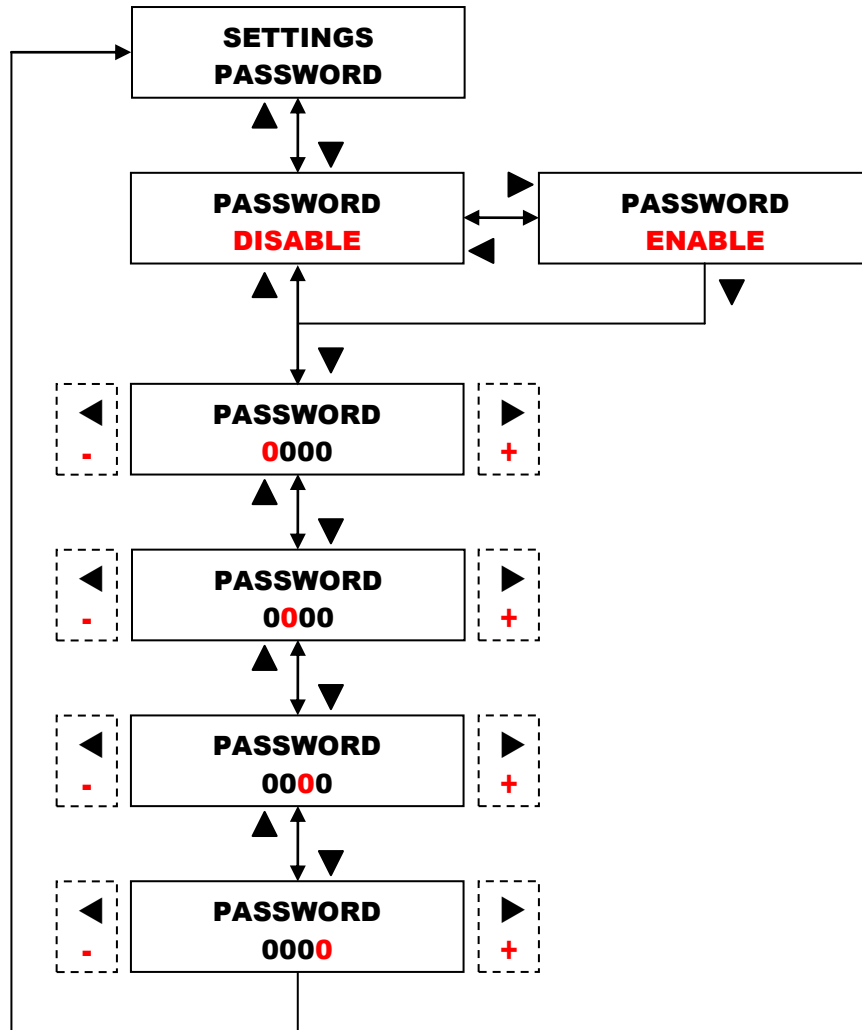

Flow diagram TEMPERATURE submenu (only metering versions)

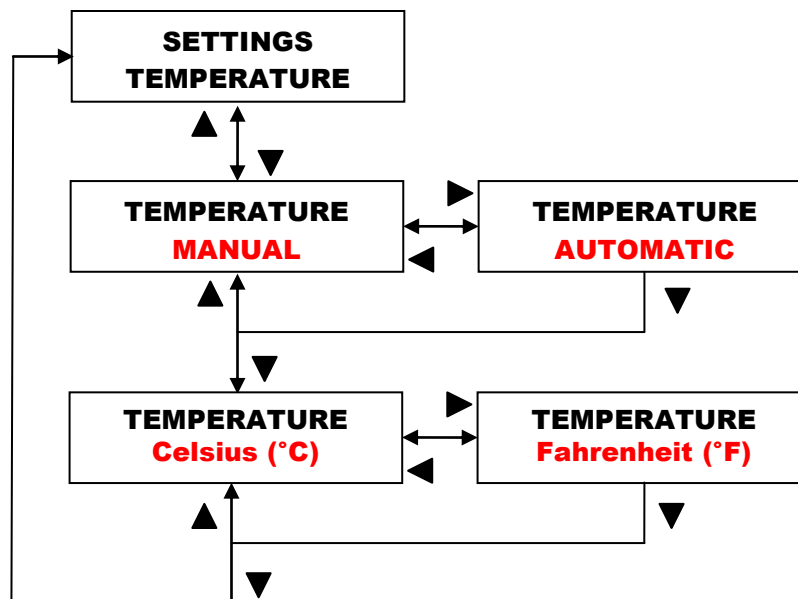

Flow diagram MODES MENU submenu (only metering versions)

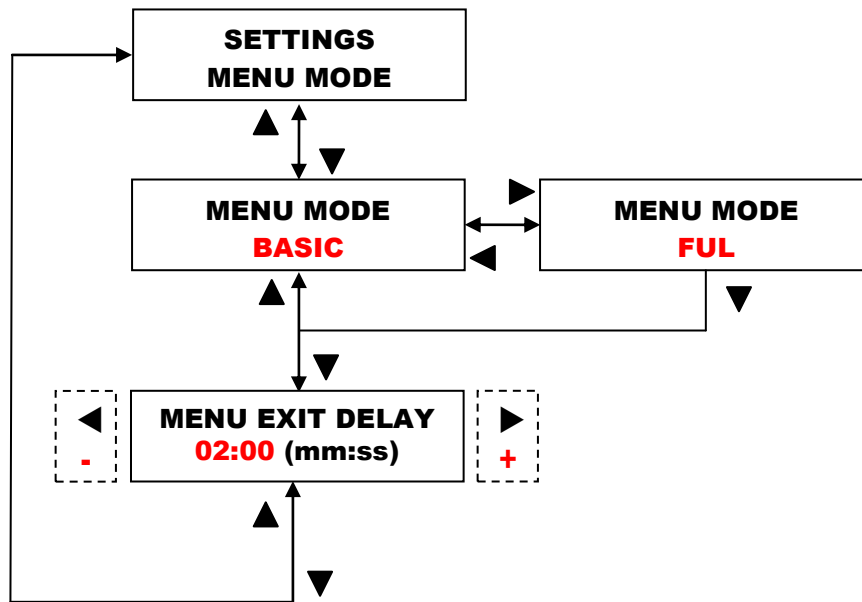

Flow diagram START DELAY submenu (only metering versions)

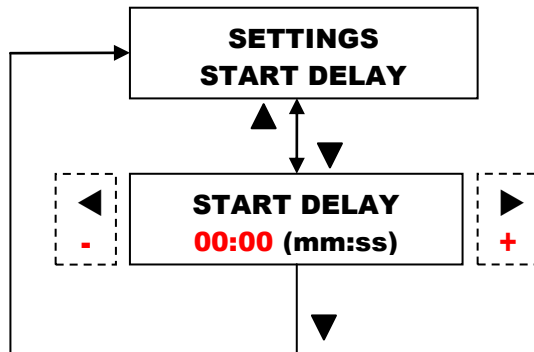

Flow diagram LANGUAGE submenu

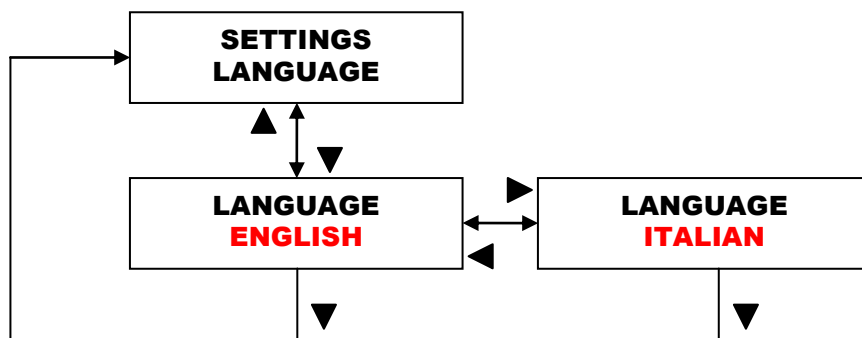

Flow diagram RESET submenu

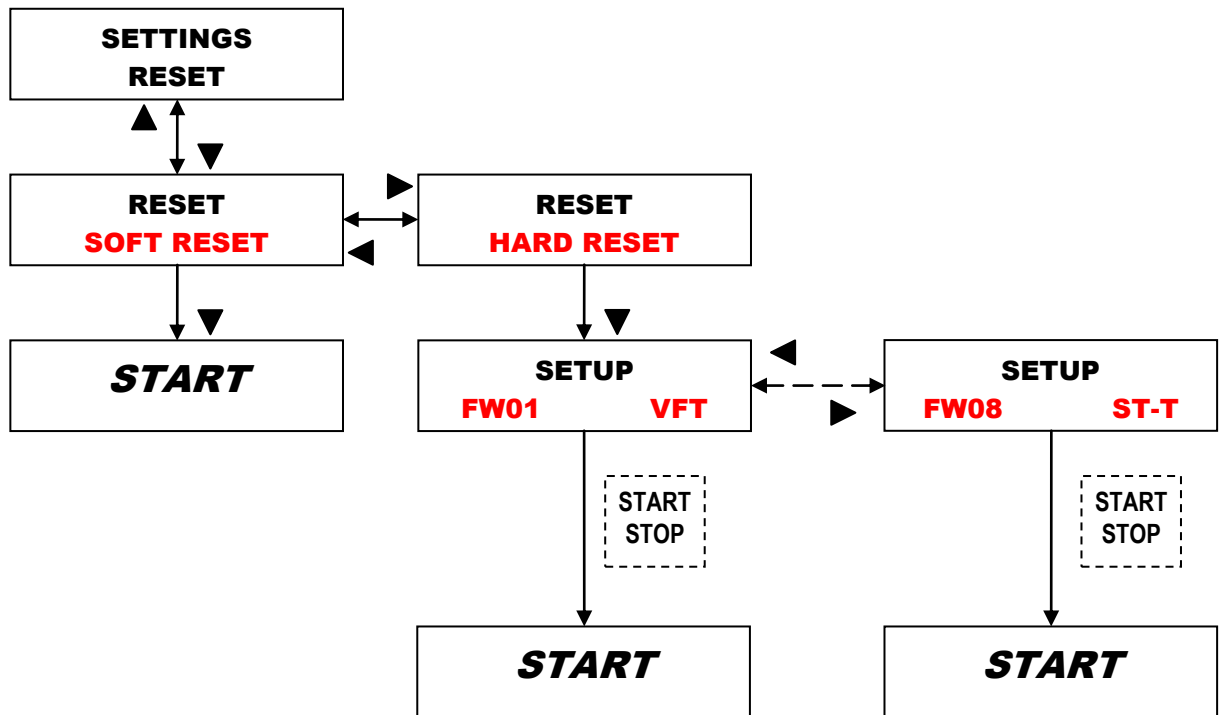

ALARMS



The PLUS Metering pump has the ability to monitor the proper functioning of the system and signal some alarm situations that may occur. It can specifically detect the following alarms:

- Level alarm
- Flow switch alarm
- Meter impulse alarm that intervenes in the 1xN (M) function - *only proportional versions*
- Meter impulse alarm in PPM - *only proportional versions*
- Meter impulse alarm in ml X m³ - *only proportional versions*
- Maximum value alarm - *only control versions*
- Minimum value alarm - *only control versions*
- Overdose alarm - *only control alarms*
- OVERLOAD alarm
- UNDERLOAD alarm

All alarm conditions are indicated by the lighting of the LED on the control panel and on the display. The switching of the alarm relay also occurs (contacts 19, 20 and 21 fig.9) if enabled, where applicable, by the different configuration menus. Relay switching occurs in all situations where enabling doesn't occur.

Level alarm

The floating level sensor signals when the liquid to be dosed into the tank is finished. The pump will stop, indicating the alarm status. Connect the level sensor to the pump terminal box (see fig. 9), in correspondence to terminals 5 and 6, and introduce it into the tank containing the additive to be dosed. In order to prevent false alarms due to fluctuations in the liquid level itself the alarm occurs with a delay of at least 3 sec.

Flow switch alarm

The electronic circuit of the pump, registers every blow given by the electromagnet, which is matched by an injection of product from the pump body. In some cases the injection may not occur as a result of wear of pump body parts, the valves, the O-rings, the presence of air, etc.

In the pumps equipped with a flow switch (hydraulic device which shows the actual passage of fluid) if the missed injections occur within the sampling interval exceed the set parameters, the flow switch alarm triggers and the injections stop. The parameters to set are the following:

**REFERENCE IMPULSES
MAX DIFFERENCE**

**Number of impulses that the circuit samples
Maximum number of pulses permissible within the sampling interval,
that cannot be effectively provided**

To better explain this function, consider for example, a sampling interval set to 100 impulses and a maximum allowable difference of 10 pulses. The circuit memorises the impulses of the electromagnet and in correspondence to each of these it expects a corresponding closing of the contact of the flow switch connected to the hydraulic delivery of the pump. If the closures recorded are greater than or equal to 90 (100-10 = 90), the pump is operating normally and repeats the next sampling cycle. If, however, the closures recorded are less than 90 the pump goes into alarm mode signalling the situation in the manner indicated above.

Within the programming menu you can choose whether or NOT to STOP the metering in the case of an alarm.

Meter impulses alarm (only proportional versions)

The impulse meter alarm activates in the multiplicative operation modes, namely: **1 x N (m), PPM e ml x m³**.

This alarm is activated when the number of pulses generated by the meter is such as to require the pump to run at a higher frequency than the maximum. This event may be generated by an incorrect programming or an incorrect choice of the meter or by the metering pump in relation to the plant to be treated. The user in the programming menu can choose whether to enable this type of alarm. It is recommended however to enable it to provide a greater guarantee of correct metering and sizing check. It is also possible to choose, always within the programming menu, whether or NOT to STOP the metering in the case of an alarm.

The alarm activates when the number of injections memorised and not dispensed **exceeds the value 4 * N** where N is the number of injections to be given for each meter impulse. On the pump display the number of injections to be yet delivered is shown in dynamic mode. The choice of factor 4 is an easy way to prevent any transient phenomena generating false alarms.

If the activation of this alarm is frequent it is recommended that the operator checks the operating conditions of the plant.

Maximum value and minimum value alarms (Instrument versions only)

The control pumps, by the metering, control the maintenance of the values of the electrochemical parameters of the water (pH, Redox, Cl, ppm) within the parameters set during the programming of the pump.

During normal operation of the system anomalies can bring the measured values outside the normal values. On the eOne pump two alarm thresholds can be set, respectively "MAXIMUM VALUE" and "MINIMUM VALUE". Once exceeded, the operator must intervene to analyse the cause that led to the activation of this alarm and to restore the correct operating conditions.

Common causes that can generate this alarm situation may be:

- Lack of additive within the suction tank;
- Obstruction of the pump;
- Losses in the treatment system;
- Incorrect concentration of additive dosed;
- Sensor breakage;

Through the appropriate menu, you can define the maximum value beyond which the pump stops, signalling the alarm and activating the signalling relay. The operator must intervene immediately, analyse and remove the possible causes that generated the alarm.

Overdose alarm (only Instrument versions)

As described in the previous paragraph, faults can occur during operation, and although the pump is working properly, the set values are not achieved. In this case there is a potential danger due to an overdose.

Common causes that can generate this alarm situation may be:

- Lack of additive within the suction tank;
- Obstruction of the pump;
- Losses in the treatment system;
- Incorrect concentration of additive dosed;
- Sensor breakage;

To prevent these critical situations, within the programming menu, a time threshold in hours / minutes defined as "OVERDOSE ALARM" can be set, which once exceeded the pump stops, signalling the alarm and switching the relevant relay. You will need an operator to analyse and remove the cause that generated the alarm situation and to restore normal operating conditions.

Generally, the user knows the plant operating conditions and is able to evaluate the time necessary, of the pump, to restore the correct operating values of the plant. It is recommended to add to the estimated time some extra time to allow for a fair margin, always and however, to return to the correct operating conditions of the plant itself.

UNDER-LOAD and OVER-LOAD alarms

The innovative HRS technology has enabled the development of a range of metering pumps that have the ability to detect any changes in pressure inside the plant or malfunctions related to these variations. The pump is able to provide useful information about the state of operation. Specifically, this is expressed in the availability of two different types of signals.

a) **UNDERLOAD:** If during normal operation the pump has no fluid to be metered which may be caused by problems on the suction line: clogged filter or damaged valves, the pump goes into UNDERLOAD status. This condition is indicated by the signal on the display, the ALARM LED lights up and activates the corresponding relay (if enabled). The pump stops after approximately 20 injections.

b) **OVERLOAD:** The pump during normal operation performs a check (in real time) on the pressure conditions in the plant. If this pressure exceeds the maximum allowed (plate setting), the instrumentation of the pump reacts reporting this state with a message on the display, the ALARM LED lights up and the relay activates. Even in this case, the stopping of the pump occurs after 20 injections from the occurrence of the event.

The UNDER-LOAD and OVER-LOAD functions can be enabled and disabled using the respective setup menu. **The factory settings for the UNDER LOAD and OVER LOAD functions are disabled.**

Relay services output

Within each alarm submenu an alarm relay can be enabled, and the choice of switching mode from NO to NC and vice versa, in the following cases:

- Level alarm
- Flow switch alarm
- Meter impulse alarm that intervenes in the 1xN (M) function (*only proportional versions*)
- Meter impulse alarm in PPM (*only proportional versions*)
- Meter impulse alarm in ml x m3 (*only proportional versions*)

Instead, in the following alarm situations the relay always switches:

- Maximum value alarm (*only control versions*)
- Minimum value alarm (*only control versions*)
- Overdose alarm (*only control versions*)
- UNDERLOAD alarm
- OVERLOAD alarm

FLOW DIAGRAM ALARM SETTINGS MENU

From the settings menu

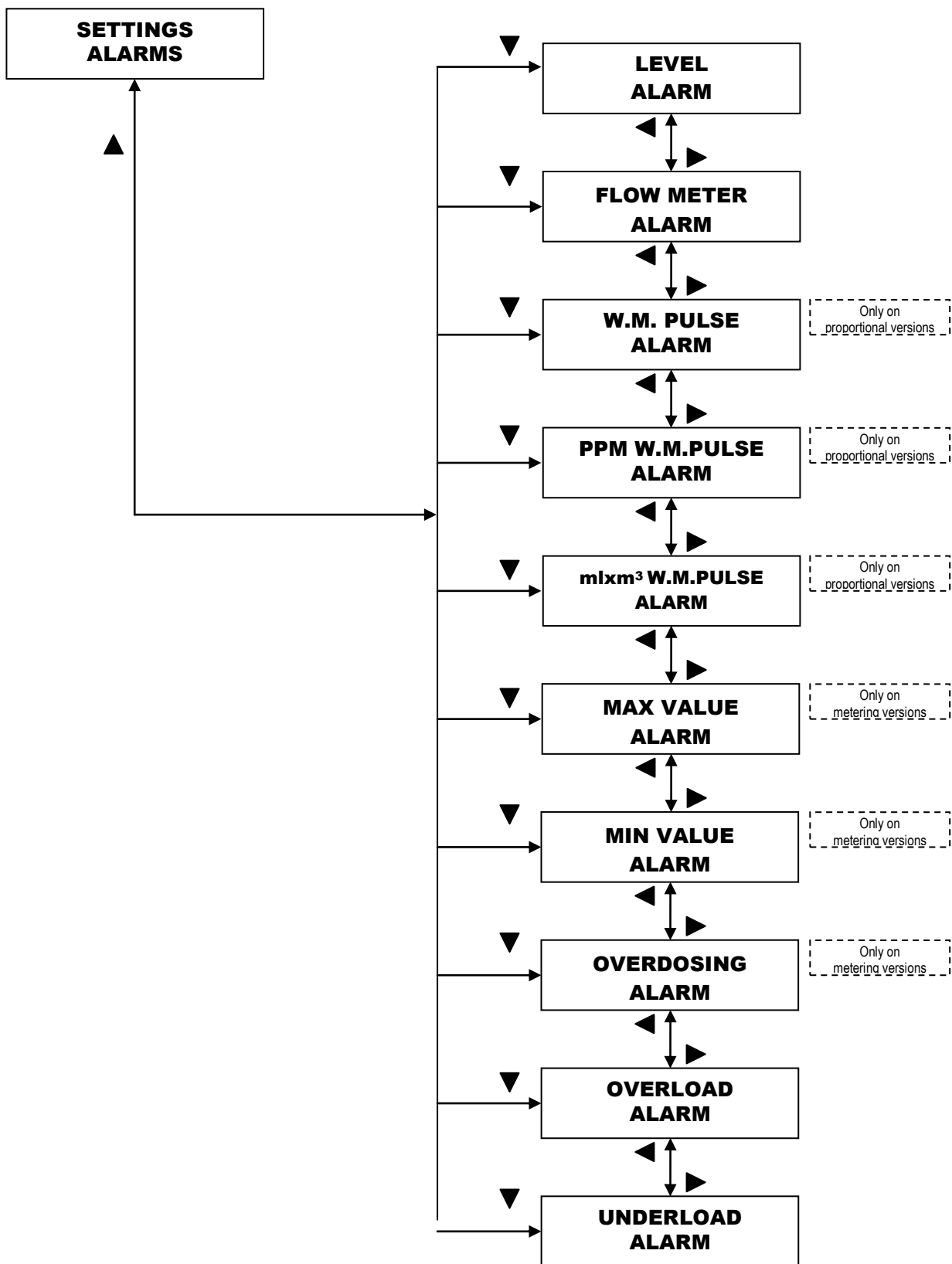

Flow diagram LEVEL ALARM

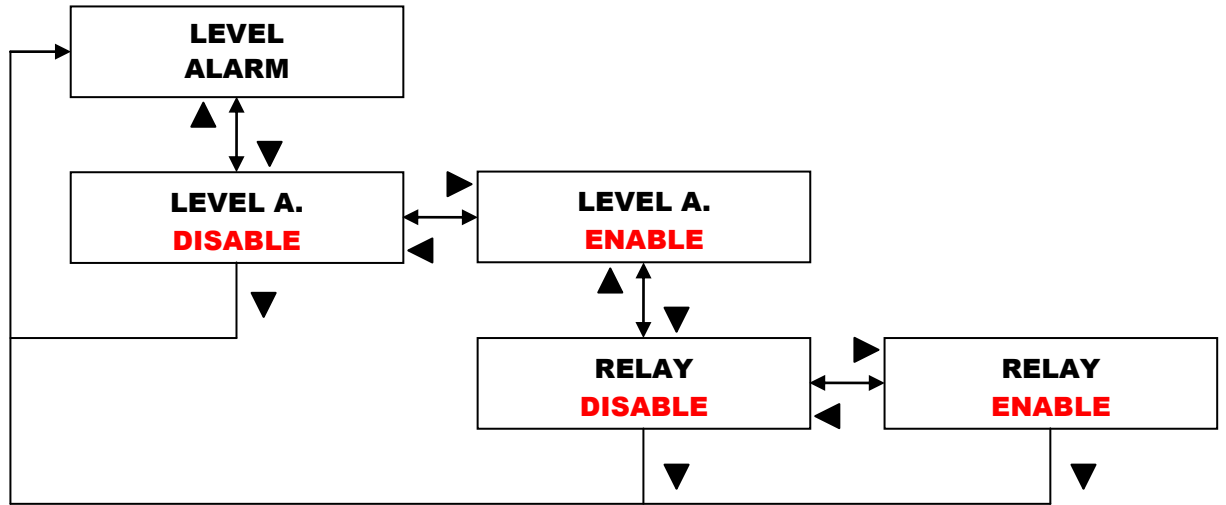

Flow diagram FLOW METER ALARM

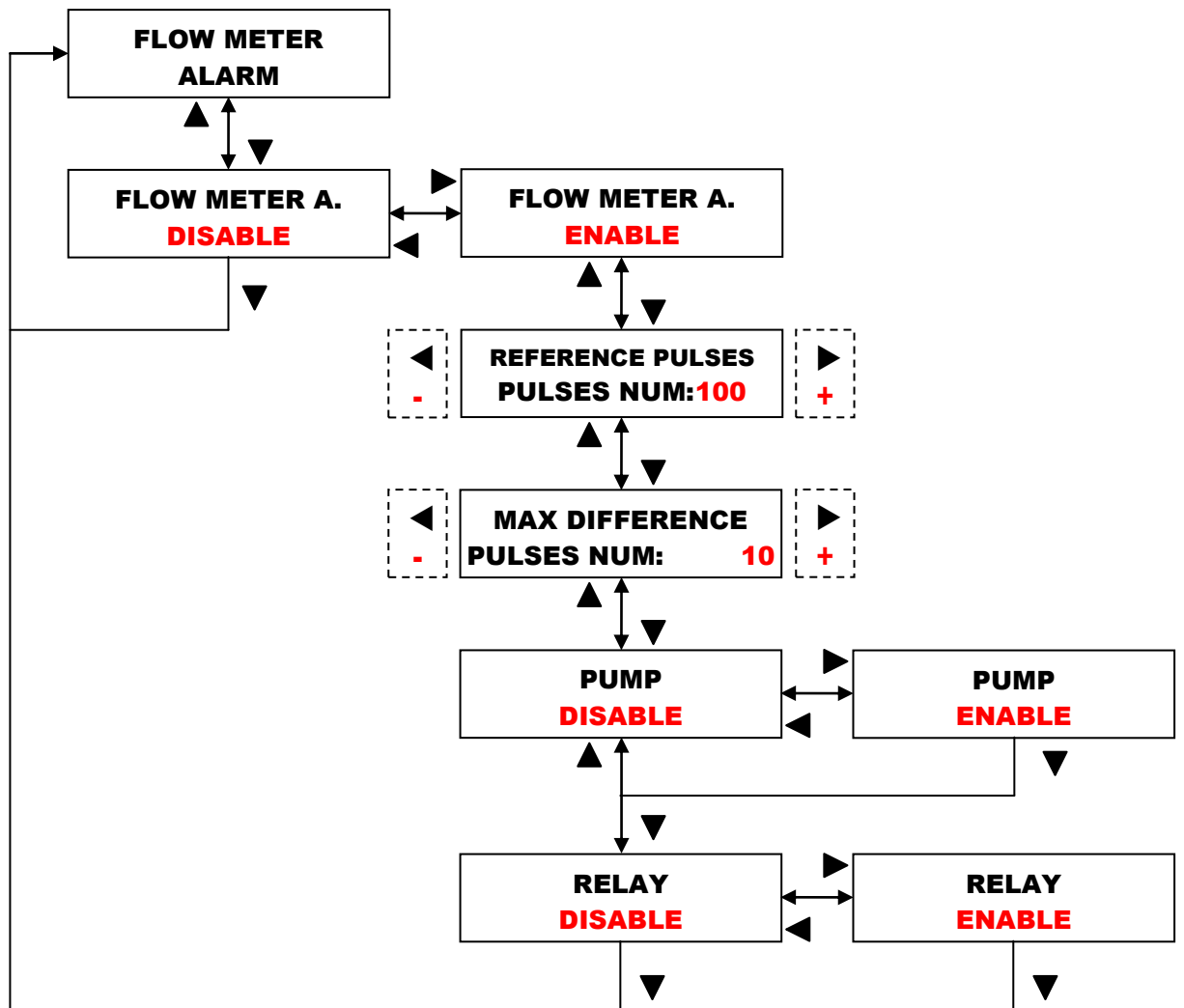

Flow diagram WATER METER PULSE ALARM (proportional versions only)

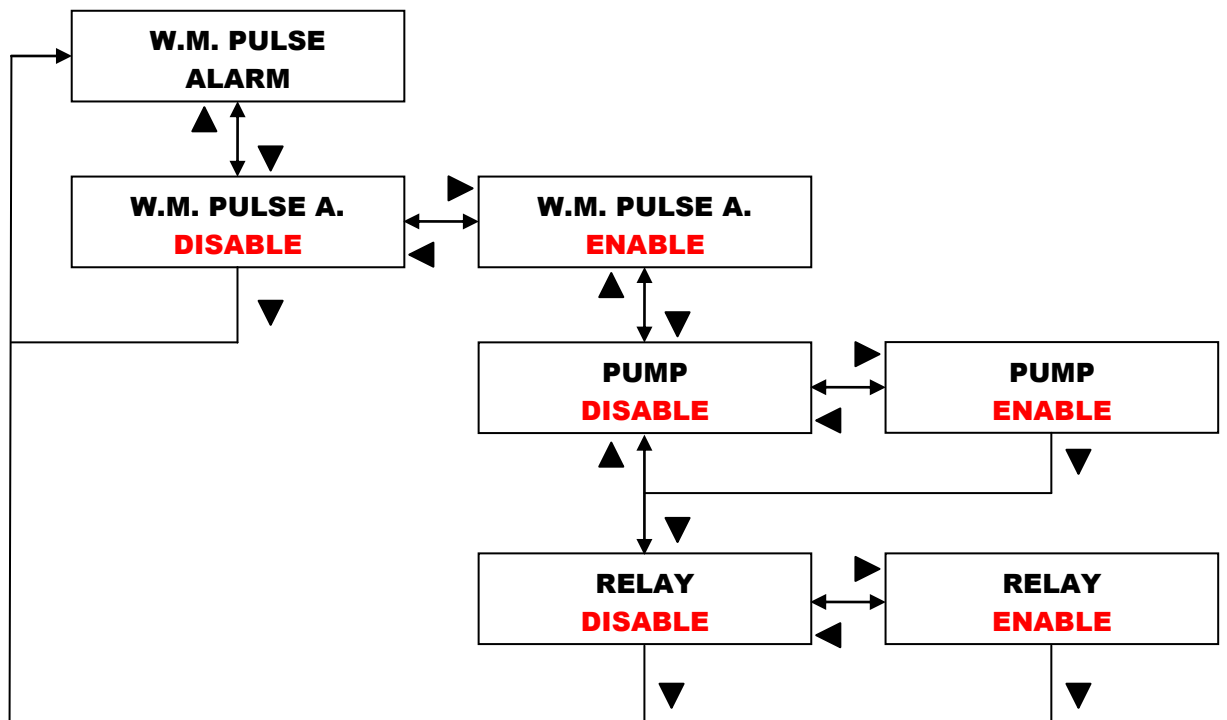

Flow diagram PPM WATER METER PULSE ALARM (proportional versions only)

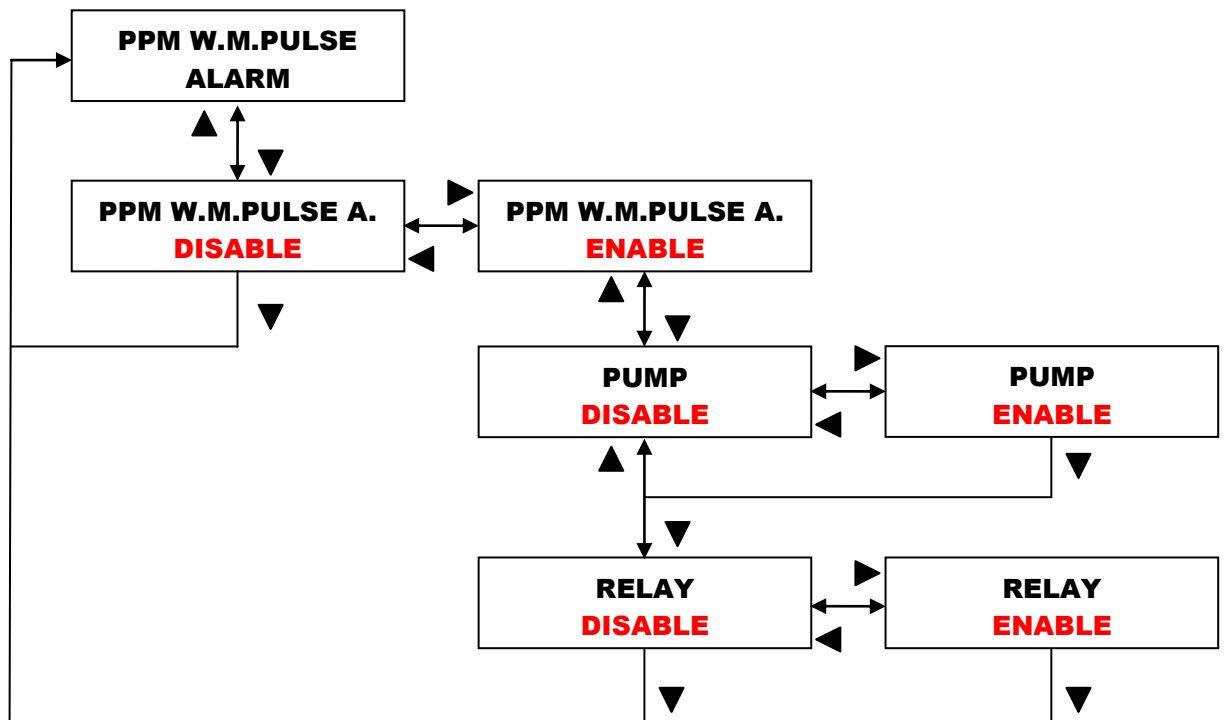

Flow diagram ml x m³ WATER METER PULSE ALARM (proportional versions only)

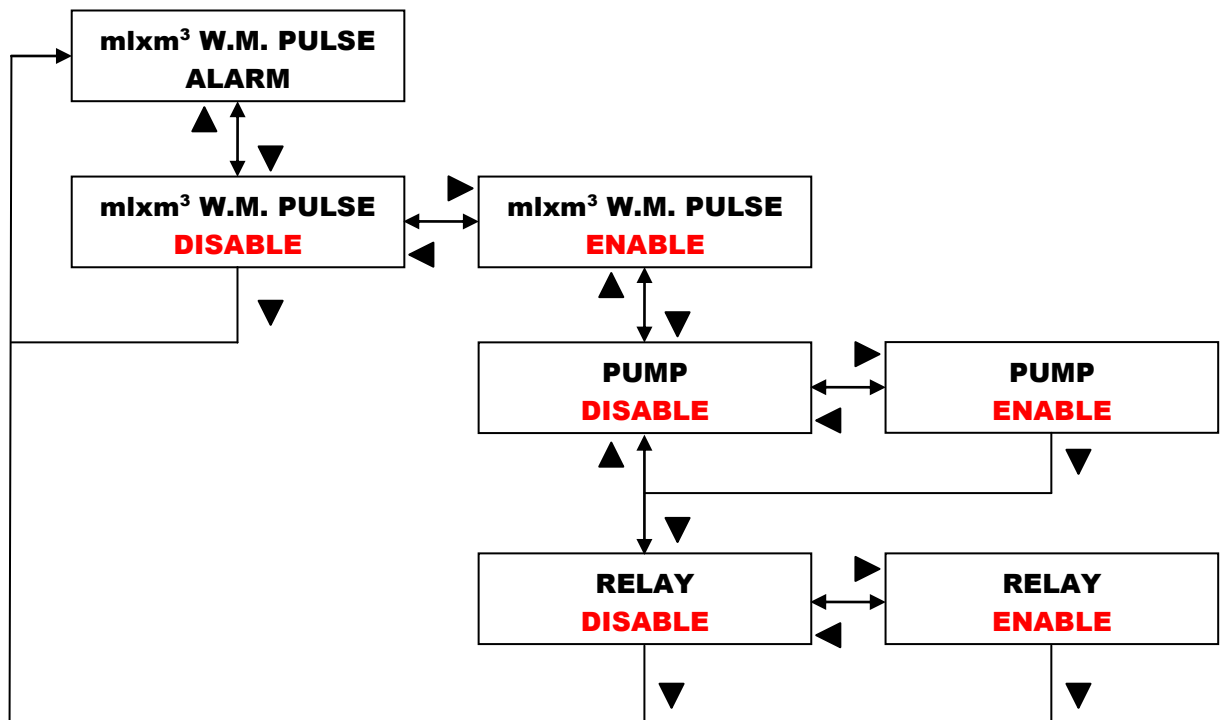

Flow diagram MAXIMUM MEASURE ALARM (metering versions only)

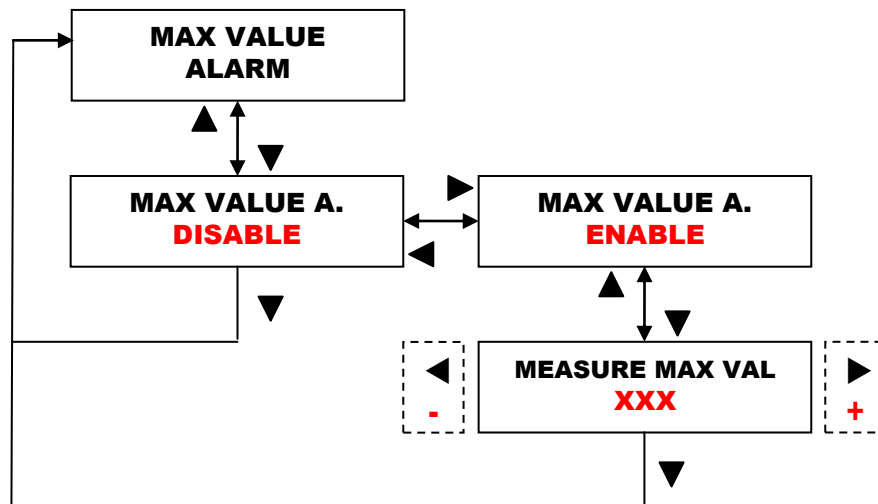

Flow diagram MINIMUM MEASUREMENT ALARMS (metering versions only)

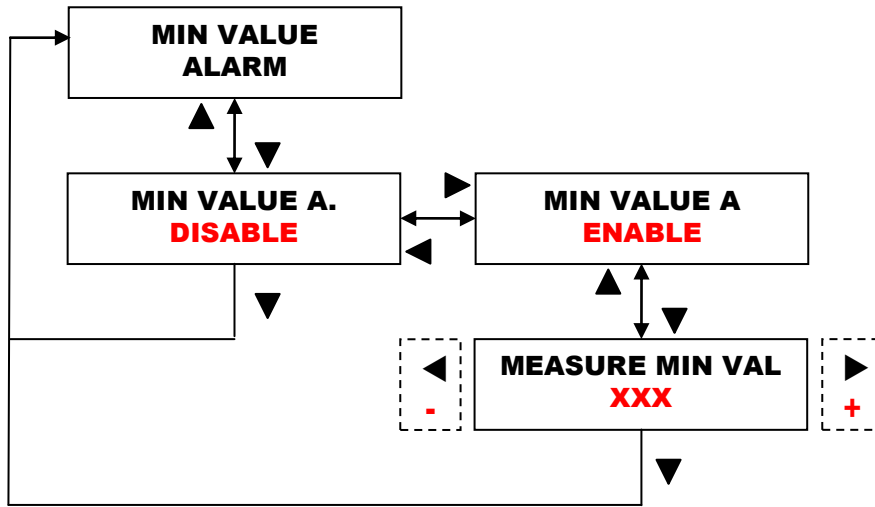

Flow diagram OVERDOSE ALARM (metering versions only)

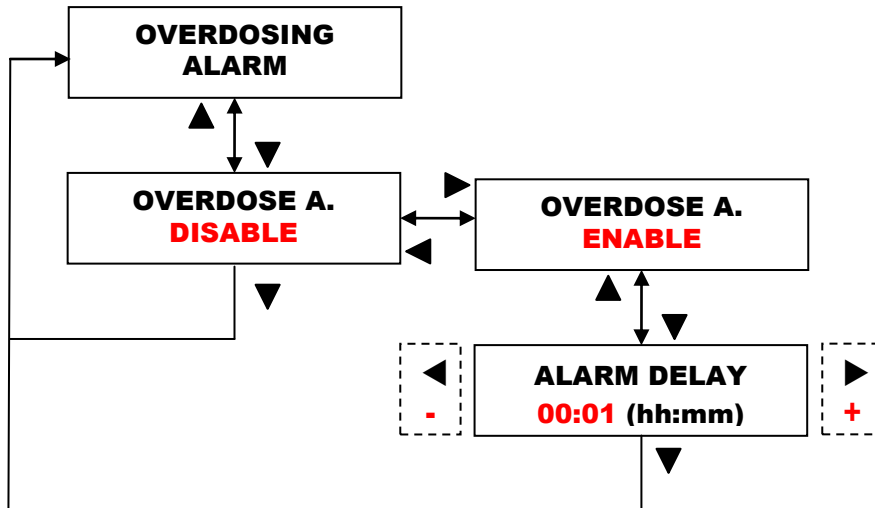

Flow diagram OVERLOAD ALARM

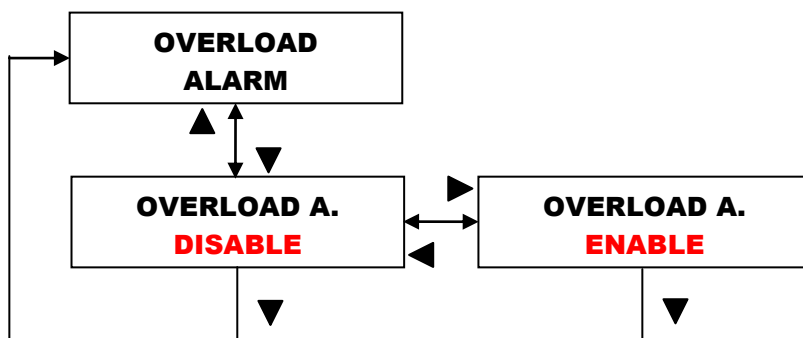

Flow diagram UNDERLOAD ALARM

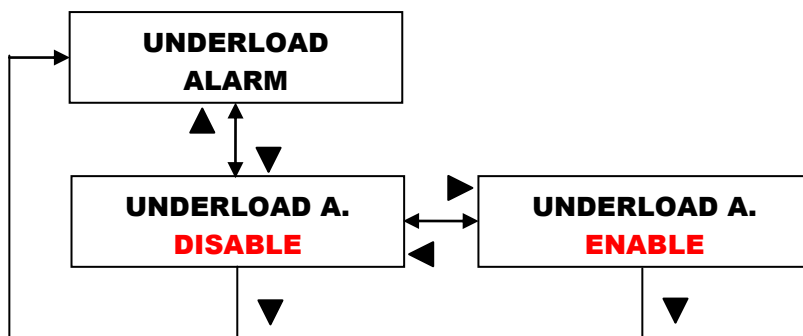

PROGRAMMABLE TIMER FUNCTION DAILY AND WEEKLY

The TIMER settings menu is present in the configurations VFT-T VFT-ST, MF-T and ST-T. The Timer menu function allows you to manage the operating status of the metering pump over all the set functions. The timer is structured in such a way that you can have 16 start cycles in a day (Pump On) and Stop (Pump not operating). It is also possible to manage 16 cycles of start and stop for each day of the week. The following selections can be made:

- DISABLE TIMER** The timer is deactivated.
- DAILY TIMER** By enabling this selection, the user can choose 16 cycles of start and stop throughout the day.
- WEEKLY TIMER** By enabling this selection, the user can choose 16 cycles of start and stop, over every single day of the week: Monday, Tuesday, etc.

Flow diagram TIMER function

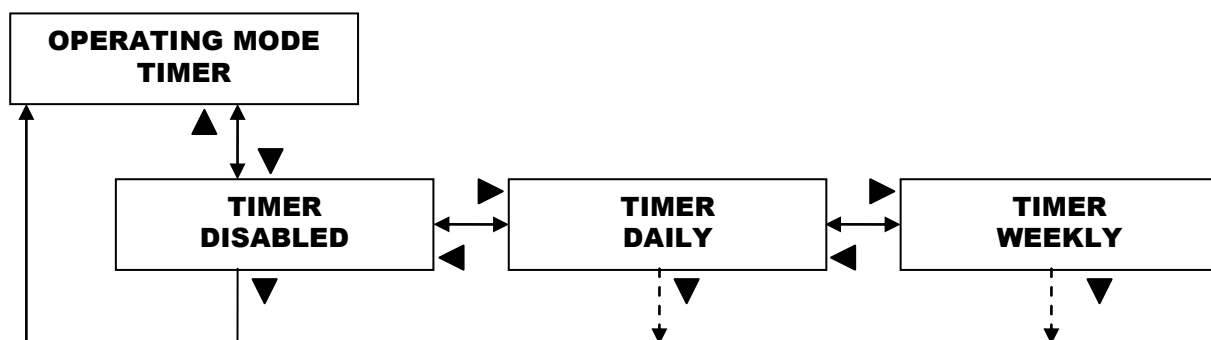

(Flow diagram TIMER function follows)

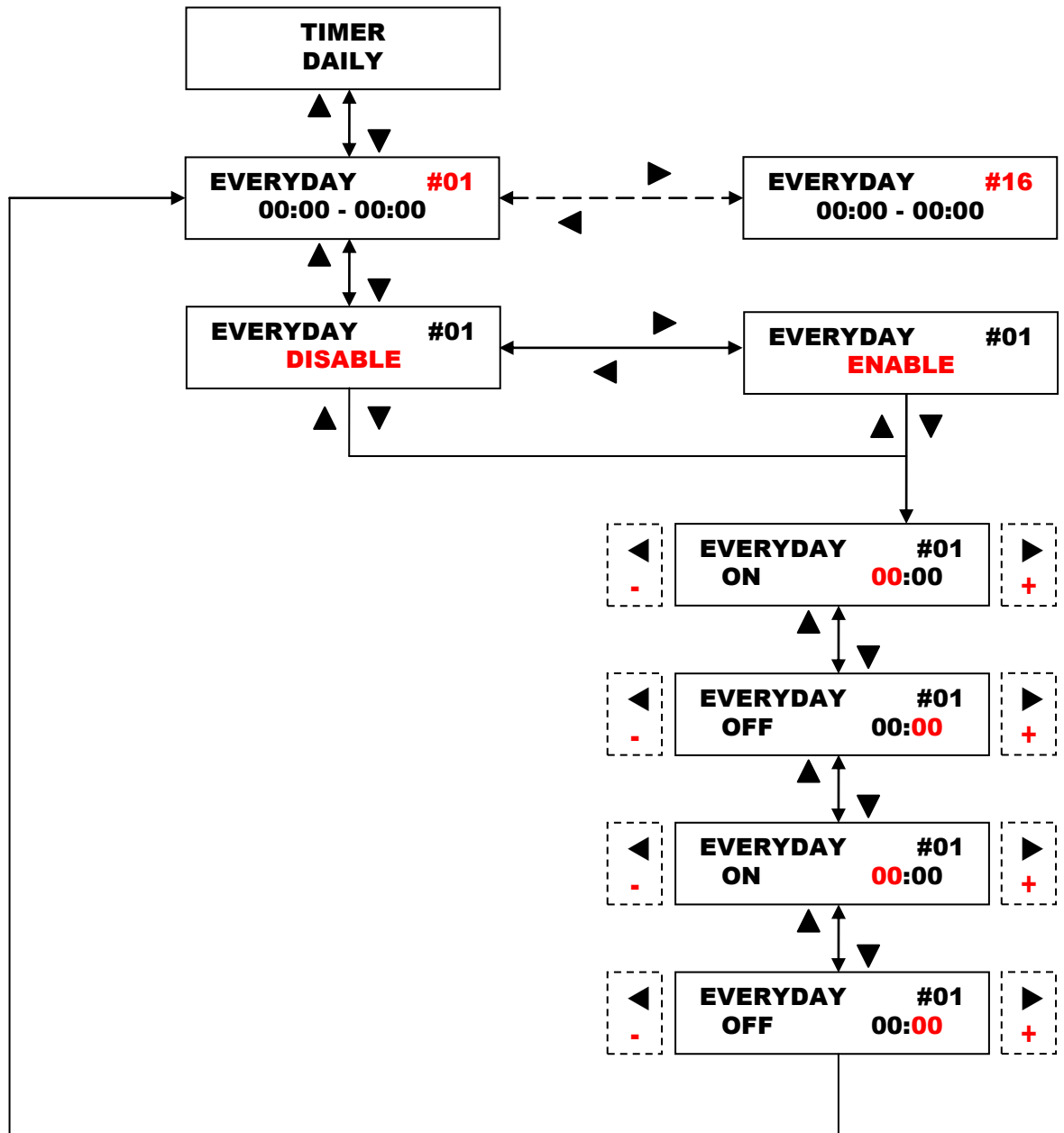

(Flow diagram TIMER function follows)

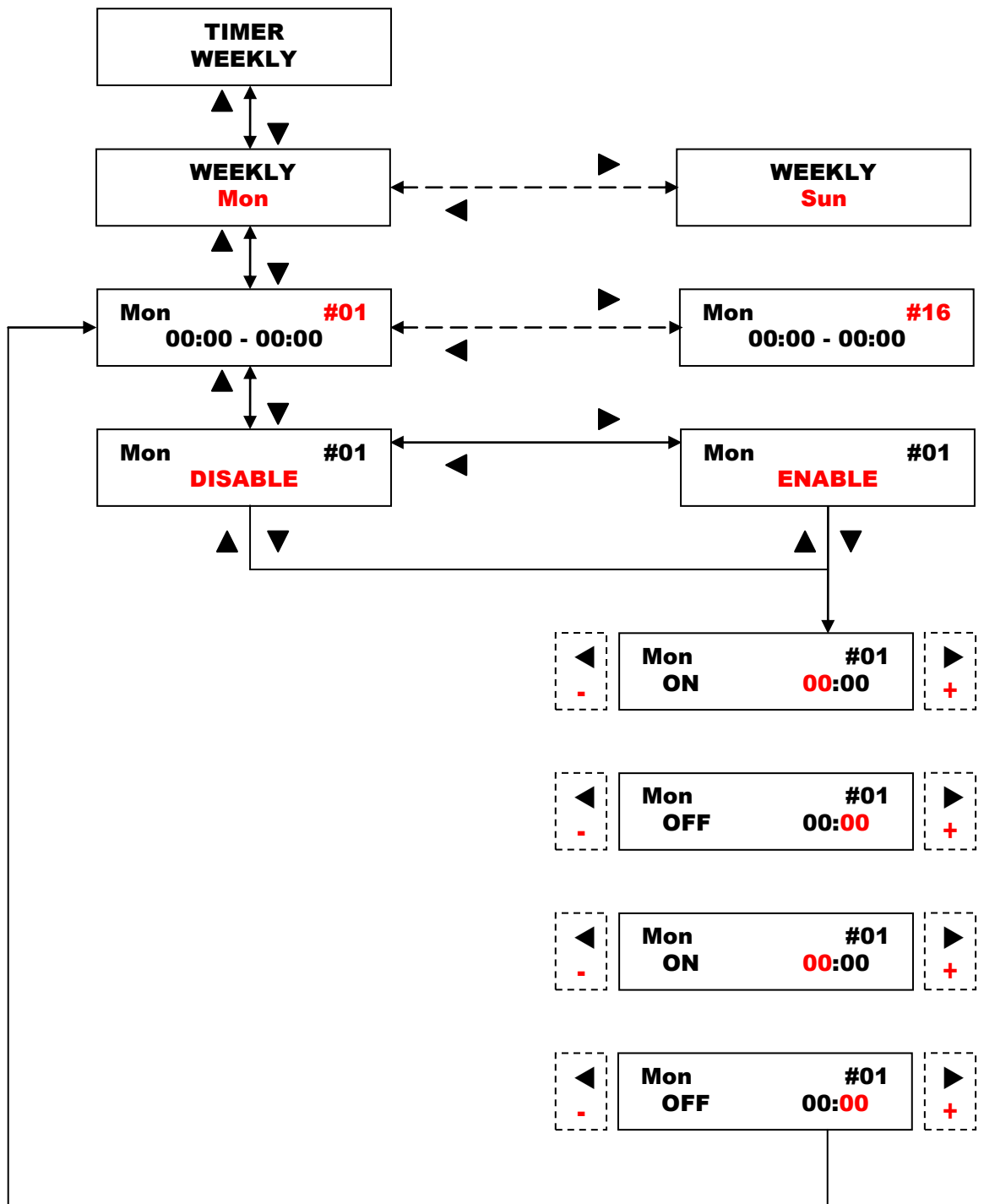

ROUTINE MAINTENANCE



A thorough and routine maintenance, together with a scheduled inspection, ensures long preservation and good functioning of the systems. We therefore recommend you follow our routine maintenance advice and to enter into a programmed service and assistance contract with one of our trusted Technical Support Centres.

At least every 6 months check the operation of the pump. In the case of intensive use of the metering pump, it is recommended to increase the frequency of checks.

Check that there are no deposit formed in the heads, if so they can be removed by disassembling the piece and thoroughly washing it with water. For difficult deposits, removal is recommended by immersing it in an aqueous solution of hydrochloric acid, then rinsing the piece thoroughly with water.

Regularly check the seals of the check valves, the diaphragm and all the seals, because they can deteriorate over time as part of normal wear and tear.

To replace the diaphragm unscrew the 4 screws, unscrew the diaphragm, replace it together with the 'O'Ring, put everything back in, making sure to tighten the screws in a balanced manner (alternatively tighten crosswise with the prescribed torque (see Annex 1))

Regularly check and replace the sealing of the injection valve, because it could be subject to deterioration due to use and as it performs a retainer function it may result in a return of the metered product in the pump.



Warning: When removing the metering pump from the plant, exercise caution when removing the pipe from the discharge connection, as additive residue in the pipe may spill out. Even in this case, if the case comes in contact with the additive it must be cleaned.

Warning: when the power supply is switched off the pump may issue one or more pulses, therefore before removing the pipes make sure that the pump is fully switched off.

UNSCHEDULED WORK IN THE EVENT OF A BREAKDOWN



All components supplied by us are chosen and tested in accordance with strict selection principles and they therefore provide, over a long period of time, reliability and functionality to our equipment.

MECHANICAL FAULTS

Given the robustness of the system, mechanical failures do not occur. Sometimes liquid may leak from a loose connection or nut, or more simply by the rupture of the injection tube. Rarely can leaks be caused by the rupture of the membrane or by the wearing of the membrane seal itself. These components, in this case, must be replaced by removing the four screws on the pump body, refitting these screws, and tightening them uniformly with a maximum torque of 180 to 200 N * cm. Once you have resolved the leak, the pump must be cleaned of any residual additive, which if left to stagnate, it could deteriorate the outer shell and the parts next to the electromagnets.

THE METERING PUMP GIVES IMPULSES BUT DOES NOT INJECT ADDITIVE INTO THE PLANT

- Remove the suction and discharge valves, clean them and replace them in the same position. In case you experience a bulging of the seals, check the degree of chemical compatibility with the additive metered by the pump.
- Check the clogging of the bottom filter;
- Check the injection valve.

ELECTRICAL FAULTS

NO LED LIT, THE PUMP DOES NOT INJECT.

- Check that the pump is correctly powered (socket and plug) If the pump remains inactive, please contact one of our Customer Service Centres.

ANNEX 1 - PUMP DRAWINGS

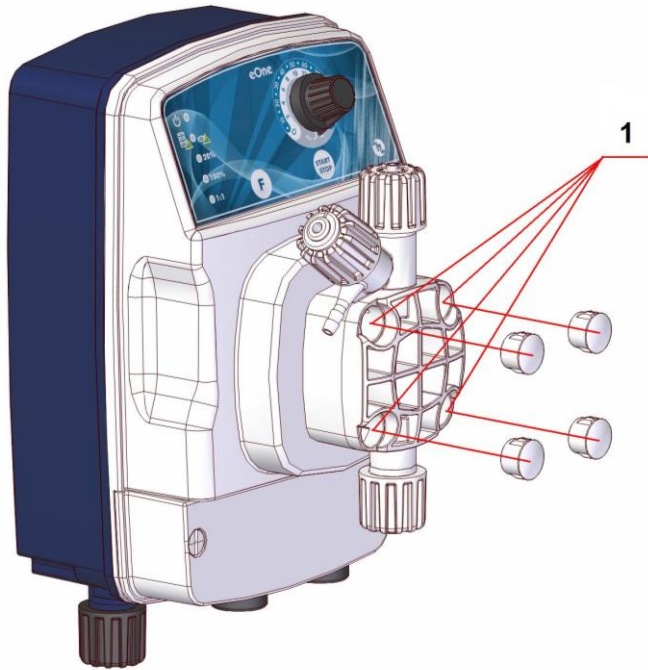

1. screws pump body

tighten with a torque of 180 - 200 N
* cm with a 2.5 mm hex wrench

TERMINALS DATA SHEET

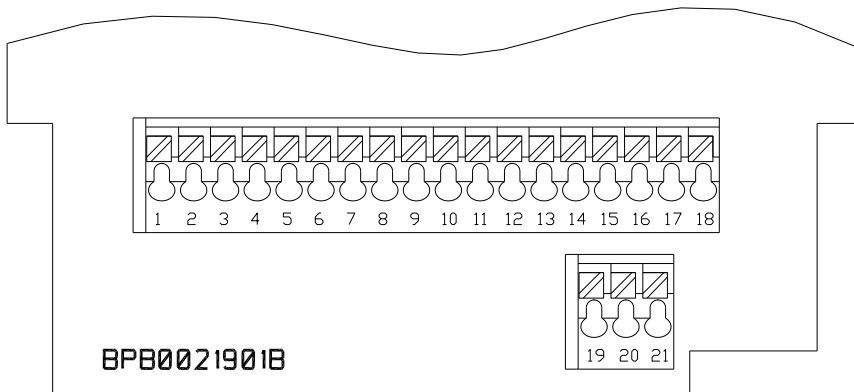

- 1 Input mA (-)
- 2 Input mA (+)
- 3 Meter Input (-)
- 4 Meter Input (+)
- 5 Level Input (-)
- 6 Level Input (+)
- 7 Flow Switch Input (-)
- 8 Flow Switch Input (+)
- 9 Output mA (-)
- 10 Output mA (+)
- 11
- 12
- 13
- 14 PT100 Input (-)
- 15 PT100 Input (+)
- 16 Probe (Cl) PPM (GND)
- 17 Probe (Cl) PPM (-VCL)
- 18 Probe (Cl) PPM (+VCL)
- 19 Alarm Relay (NO)
- 20 Alarm Relay (NC)
- 21 Alarm Relay (COM)

ANNEX 2 – ENLARGED VIEWS (PUMP AND INJECTION VALVE)



Fig. 1

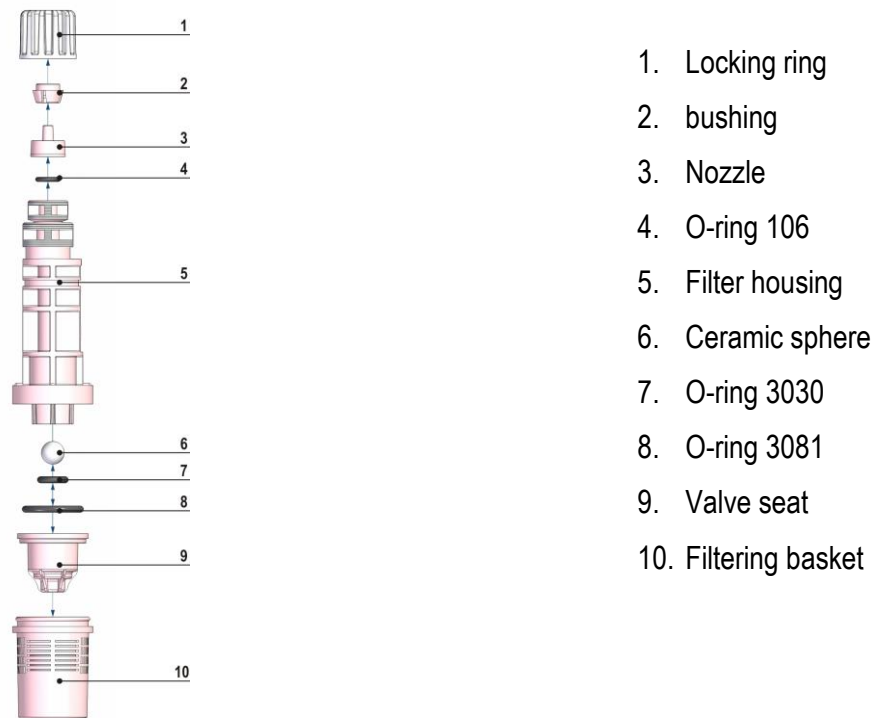

ANNEX 2 - ENLARGED VIEWS

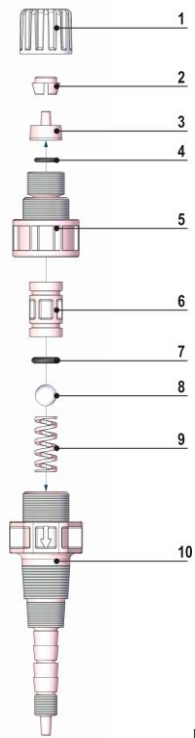

1. Locking ring
2. Bushing
3. Nozzle
4. O-ring 106
5. Injection valve fitting
6. Adaptor
7. O-ring 3024/3030
8. Ceramic sphere
9. Spring
10. Injection valve housing

Fig. 2



ETATRON D.S.



ETATRON D.S.

HEAD OFFICE - ITALY

Via dei Ranuncoli, 53 - 00134 ROMA - ITALY

Phone +39 06 93 49 891 - Fax +39 06 93 43 924

e-mail: info@etatronds.com - web: www.etatronds.com

ITALY (BRANCH OFFICE)

ETATRON D.S.
Via Ghisalba, 13
20021 Ospiate di Bollate
(MI) ITALY
Phone +39 02 35 04 588
Fax +39 02 35 05 421

ASIA ETATRON D.S.
(Asia-Pacific) PTE Ltd
67 Ubi Crescent, #03-05
Techniques Centre
Singapore 408560
Republic of Singapore
Phone +65 67 43 79 59
Fax +65 67 43 03 97

USA - CANADA - MEXICO
ETATRON AMERICA
1642 McGaw Avenue
Irvine, CA 92614
USA
Phone +1 949 251 8700
Fax +1 949 752 7867

ESPAÑA - ETATRON
DOSIFICACION Y MEDICION S.L.
Avda. Letxumboro 83
Pabellón 6
Irún (20305) ESPAÑA
Phone +34 902 09 93 21
Fax +34 943 09 03 12
www.etatron.es

BRASIL
ETATRON do Brasil
Rua Vidal de Negreiros, 108
Bairro Canindé - CEP 03033-050
SÃO PAULO SP
BRASIL
Phone/Fax +55 11 3228 5774

RUSSIAN FEDERATION
DOSING SYSTEMS
3-rd Mytishenskaya, 16/2
129626 Moscow
RUSSIA
Phone +7 495 787 1459
Fax +7 495 787 1459

UKRAINE
000 ETATRON - UKRAINE
Soborna Street, 446
Rivne, 33024 Rivne Region
UKRAINE
Phone +380 36 26 10 681
Fax +380 36 26 22 033

UNITED KINGDOM
Etatron GB
Lindum Business Park
Station Road North Hykeham
Lincoln, LN6 3QX UK
Phone +44 (0) 1522 85 23 97
Fax +44 (0) 1522 50 03 77

ETATRON FRANCE
1 Mail Gay Lussac
95000 Neuville Sur Oise
Tel: +33 (0)1 34 48 77 15
Fax: +33 (0)1 78 76 73 95

A **B** C

COD. DMU00192ML1-A (07-2013)